



Share Your Vision

PTZ Optics 12X G2 with NDI®|HX using NDI® 4



User Manual

Model Nos. PT12X-NDI-GY-G2 & PT12X-NDI-WH-G2

V2.0

(English)

Please check ptzoptics.com for the most up to date version of this document.

NewTek®, NDI®, NDI® 4, & NDI®|HX are all registered trademarks by Vizrt Group®



ptzoptics.com || 1 800 486-5276

Table of Contents

Copyright Notice	1
Preface	2
Precautions	2
Warning	2
Warranty	3
Supplied Accessories	3
FCC Statement	3
Connection Guide	4
Features	5
Technical Specifications	6
NDI® HX with NDI® 4 Connection	7
IR Remote Controller Guide	8
Dimensional Drawings (mm)	10
RS-232 Interface	11
RS-485 Interface	11
Serial Communication Control	12
PTZOptics VISCA Command List	13
On Screen Display Menu	23
Network Connection	26
Assigning an IP Address	27
Using the Upgrade Tool	27
Discovering your Network Info	30
Camera Web Interface	31
PTZOptics HTTP-CGI Camera Control	37
Photobooth Functionality	39
Maintenance and Troubleshooting	40
Certifications	41
Changelog	41

Copyright Notice

The entire contents of this manual / guide, whose copyright belongs to PTZOptics, may not be cloned, copied, or translated in any way without the explicit permission of the company. The product specifications referred to in this document are for reference only and as such are subject to updating at any time without prior notice.

©2021 | PTZOptics | All Rights Reserved

Preface

Thank you for using the HD Professional Video Conferencing Camera. This manual introduces the function, installation, and operation of the HD camera. Prior to installation and usage, please read the manual thoroughly. If you have any questions about the capabilities of the product, call our toll-free number 1-800-486-5276.

Precautions

- This product can only be used in the specified conditions in order to avoid any damage to the unit itself.
- Don't subject the camera to rain or moisture.
- Don't remove the cover. Removal of the cover may result in an electric shock. In addition to voiding the warranty. In case of abnormal operation, submit a ticket at help.ptzoptics.com.
- Never operate outside of the specified operating temperature range, humidity, or with any other power supply than the one originally provided with the unit.
- Please use a soft dry cloth to clean the unit. If the unit is very dirty, clean it with diluted neutral detergent; do not use any type of solvents, which may damage the surface.

Warning

- **Electrical Safety**
Installation of an operation must be in accordance with national and local electric safety standards. Do not use any power supply other than the one originally supplied with this camera.
- **Polarity of Power Supply**
The power supply output for this product is 12V DC with a maximum current supply of 2A. Polarity of the power supply plug is critical and is as follows:



- **Handling**
 - Avoid any stress, vibration, or moisture during transportation, storage, installation, and operation.
 - Do not lift or move the camera by grasping the camera head. Do not turn the camera head by hand. Doing so may result in mechanical damage.
 - Do not expose the camera to any corrosive solid, liquid, or gas to avoid damage to the cover which is made of a plastic material.
 - Ensure that there are no obstacles in the pan or tilt ranges of the camera lens.
 - Never power the camera on before installation is complete.
- **Do not dismantle the camera** – PTZOptics is not responsible for any unauthorized modification or dismantling.

Warranty

PTZOptics includes a limited parts & labor warranty for all PTZOptics manufactured cameras. The warranty is valid only if PTZOptics receives proper notice of such defects during the warranty period. PTZOptics, at its option, will repair or replace products that prove to be defective. PTZOptics manufactures its hardware products from parts and components that are new or equivalent to new in accordance with industry standard practices.

Supplied Accessories

When you unpack your camera, check that all the supplied accessories are included:

- Camera 1
- AC Power Supply 1
- RS-232C Cable 1
- IR Remote Control 1
- Quick Start Guide 1
- AAA Batteries 2



FCC Statement

This equipment has been tested and found to comply with the limits for a Class A digital device, pursuant to part 15 of the FCC Rules. These limits are designed to provide reasonable protection against harmful interference when the equipment is operated in a commercial environment. This equipment generates, uses, and can radiate radiofrequency energy and, if not installed and used in accordance with the instruction manual, may cause harmful interference to radio communications. FCC Caution: Any changes or modifications not expressly approved by the party responsible for compliance could void the user's authority to operate this equipment. Operation is subject to the following two conditions: (1) This device may not cause harmful interference, and (2) this device must accept any interference received, including interference that may cause undesired operation.

Warning - This is a class A product. In a domestic environment, this product may cause radio interference in which case the user may be required to take adequate measures.

Remote Control Battery Safety Information - Store batteries in a cool and dry place. Do not throw away used batteries in the trash. Properly dispose of used batteries through specially approved disposal methods. Remove the batteries if they are not in use for long periods of time. Battery leakage and corrosion can damage the remote control. Do not use old batteries with new batteries. Do not mix and use different types of batteries: alkaline, standard (carbon-zinc) or rechargeable (nickel-cadmium). Do not dispose of batteries in a fire. Do not attempt to short-circuit the battery terminals.

Connection Guide

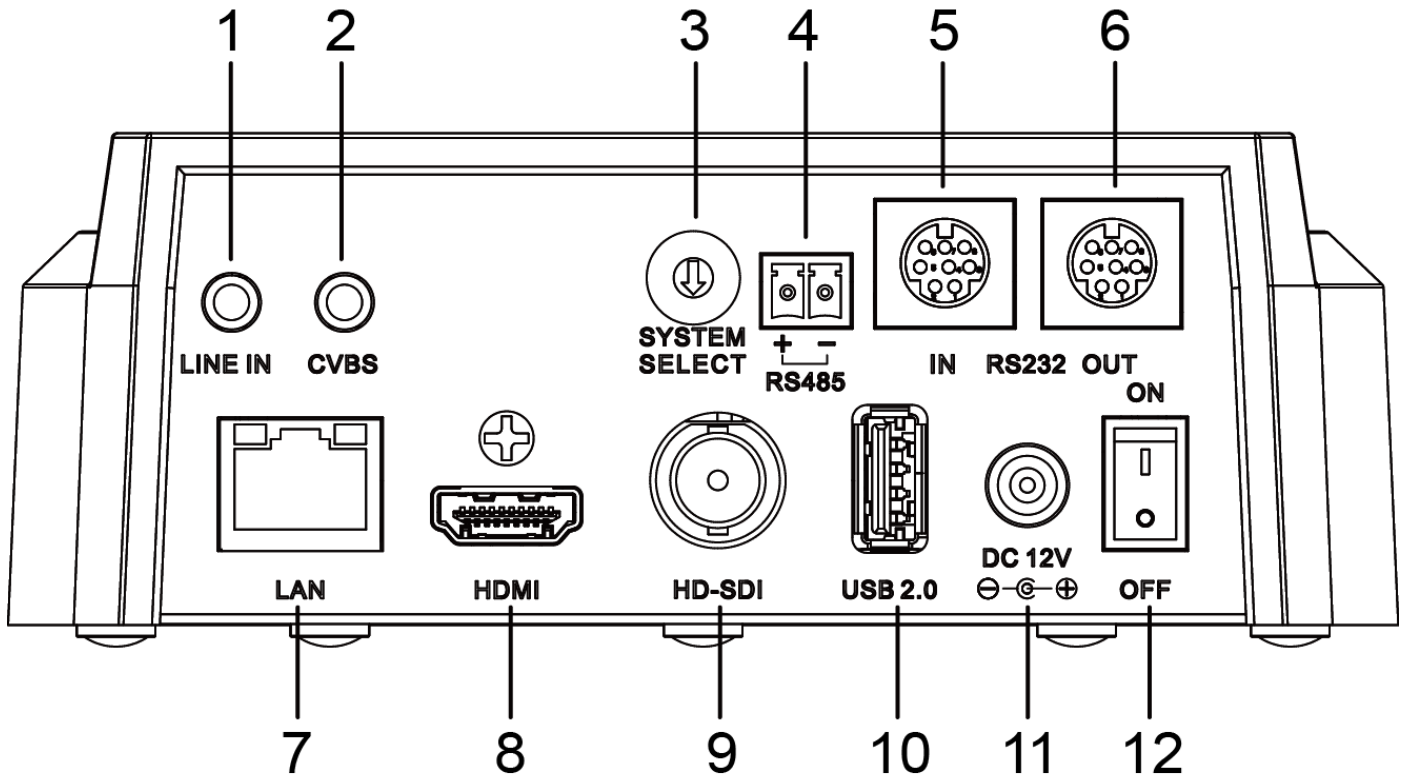

- | | |
|-----------------------|---|
| 1. Line In | 3.5mm audio connection |
| 2. CVBS | 3.5mm composite video connection |
| 3. System Select Dial | Video output resolution selector (See figure below) |
| 4. RS485 | 2-pin phoenix connection for joystick controller |
| 5. RS-232 In | 8-pin mini din connection for joystick controller |
| 6. RS-232 Out | 8-pin mini din connection for daisy chaining |
| 7. Network | RJ45 port for NDI® HX & network streaming / control |
| 8. HDMI | HDMI ver. 1.3 connection |
| 9. SDI | 3G-SDI connection |
| 10. USB 2.0 | Low level USB power (not recommended for use) |
| 11. DC12V | DC 12V power connection |
| 12. Power switch | Power camera on / off |

SYSTEM SELECT DIAL			
0	1080p 60	8	720p 30
1	1080p 50	9	720p 25
2	1080i 60	A	1080p 59.94*
3	1080i 50	B	1080i 59.94*
4	720p 60	C	1080p 29.97*
5	720p 50	D	576i 30
6	1080p 30	E	480i 30
7	1080p 25	F	720p 59.94*

After changing the System Select Dial, you will need to restart the camera to take effect.

*A, B, C, & F broadcast framerate options are considered BETA features and may not be supported by all platforms.

Features

- Image Sensor
 - Panasonic 1/2.7", 2.07 million effective pixels, HD CMOS sensor.
 - Olympus high quality telephoto lens supporting 12X optical zoom and optional 16X digital zoom.
 - Full HD 1920x1080p resolution up to 60 frames per second.
 - 2D & 3D noise reduction with our latest "low noise CMOS sensor".
 - 0.05 Lux @ F1.8 AGC On.
 - Wide angle 72.5° horizontal field of view.
 - Dynamic Range Control (DRC) for higher image quality and detail across simultaneously well lit and shadowed scenes.
 - Image Freeze to temporarily pause the video while calling presets (so viewers won't see camera movement),
 - High SNR (signal to noise ratio) of the CMOS sensor (≥55dB), combined with 2D & 3D noise reduction algorithms, effectively reduces noise, even under low illuminated conditions.
- Video Outputs
 - Simultaneous NDI®|HX / IP network streaming, 3G-SDI, & HDMI 1.3
 - NDI®|HX Full HD network streaming up to 1080p 60 frames per second.
 - 3G-SDI Full HD video output up to 1080p 60 frames per second.
 - HDMI 1.3 Full HD video output up to 1080p 60 frames per second.
 - RTSP, RTMP, & RTMPS streaming using H.264, H.265, or MJPEG.
 - Line level audio embeds over NDI®|HX / network stream & HDMI. Uses AAC audio encoding for better sound quality and lower bandwidth usage.
 - Support for ultra-high FPS mode (1280x720p @ 120 frames per second) over NDI®|HX & network streams.
 - CVBS (composite video) output via 3.5mm connector (non-simultaneous, 480i or 576i resolutions)
- Control and Settings
 - NDI®|HX control through NDI® approved platforms that offer control
 - PTZOptics VISCA over IP
 - IR Remote Control
 - Web-based IP remote control interface
 - RS-232 & RS-485 VISCA, Pelco-D, & Pelco-P control
 - P/T/Z Preset Motion Sync
- Installation
 - Standard 1/4-20 female thread for camera mounting
 - 12V DC 2A Power Supply
 - PoE 802.3af
- Warranty
 - 5-year warranty

Technical Specifications

Model Type Camera	PT12X-NDI-GY and PT12X-NDI-WH
	PTZ Optics Color Video Camera with NDI® HX using NDI® 4 HD 1080p
Video System	1080p-60/50/30/25/59.94*/29.97*, 1080i-60/50/59.94*, 720p-60/50/59.94* CVBS: 576i-30, 480i-30 *Broadcast framerates are considered BETA features and may not be supported by all platforms.
Sensor	1/2.7" CMOS, Effective Pixel: 2.07M
Scanning Mode	Progressive
Lens	12x, f3.5mm ~ 42.3mm, F1.8 ~ F2.8
Digital Zoom	16x
Minimal Illumination	0.05 Lux (@F1.8, AGC On)
Shutter	1/30s ~ 1/10000s
White Balance	Auto, Indoor, Outdoor, OnePush, Manual, VAR
Backlight Compensation	Support
Digital Noise Reduction	2D & 3D Digital Noise Reduction
Video S/N	≥55dB
Horizontal Field of View	6.9° ~ 72.5°
Vertical Field of View	3.9° ~ 44.8°
Horizontal Rotation Range	±170°
Vertical Rotation Range	-30° ~ +90°
Pan Speed Range	1.7° ~ 100°/s
Tilt Speed Range	1.7° ~ 69.9°/s
Image Flip	Support
Image Mirror	Support
Image Freeze	Support
PoE	Support (802.3af)
Face Detection	Not supported
Local Storage	Not supported
Number of Presets	255
Preset Accuracy	0.1°
Input / Output Interface	
HD Output	1 x RJ45 NDI® HX / IP Network 10/100/1000 Ethernet port
	1 x 3G-SDI: BNC type, 800mVp-p, 75Ω, Along to SMPTE 424M standard
	1 x HDMI version 1.3
SD Output	1 x CVBS: RCA jack, 1Vp-p, 75Ω
Network Interface	1 x RJ45: 10/100/1000M Adaptive Ethernet ports
Audio Interface	1 x 3.5mm audio interface, Line In (NDI® HX & IP Network stream only) (Unbalanced stereo)
USB	1 x USB 2.0 type A
Communication Interface	1 x RS-232 In: 8-pin mini DIN, Max Distance 30m, Protocol: VISCA/Pelco-D/Pelco-P
	1 x RS-232 Out: 8-pin mini DIN, Max Distance 30m, Protocol: VISCA daisy chaining only
	1 x RS-485: 2-pin Phoenix port, Max Distance 1200m, Protocol VISCA/Pelco-D/Pelco-P
IR	4 x IR Addresses, Max Distance 9m (30ft)
Power Jack	JEITA type (DC IN 12V)
IP Video Features	
Video Compression	NDI® HX using NDI® 4/ H.264 / H.265 / MJPEG
Video Stream	Two (2) IP video output streams available
First Stream Resolutions	1920x1080, 1280x720, 1024x576, 960x540, 640x480, 640x360
Second Stream Resolutions	1280x720, 1024x576, 720x480, 720x408, 640x360, 480x270, 320x240, 320x180
Video Bitrate	32Kbps ~ 102400 Kbps
Bit Rate Type	Variable Rate / Fixed Rate
Frame Rate	50Hz: 1 ~ 50 FPS, 60Hz: 1 ~ 60 FPS
Audio Compression	AAC
Audio Bit Rate	96Kbps, 128Kbps, 256Kbps
Supported Protocols	TCP/IP, HTTP, RTSP, RTMP, DHCP, Multicast, NDI® etc.
Generic Specifications	
Input Voltage	DC 12V / PoE (802.3af) (optional)
Current Consumption	1.0A (Max)
Operating Temperature	-10°C ~ 40°C (14°F ~ 104°F)
Storage Temperature	-40°C ~ 60°C (-40°F ~ 140°F)
Humidity Range	10% - 80%
Power Consumption	12W (Max)
MTBF	>30000h

Size in. (W x D x H)	5.6" W x 6.7" D 164" H (7.88" H max height w/ tilt up)
Size mm. (W x D x H)	142mm W x 169mm D x 164" H (189mm H max height w/ tilt up)
Camera Weight	3.2 lbs. (1.445 kg)

NDI®|HX with NDI® 4 Connection

The NDI®|HX connection allows you to connect and control your camera through any NDI® compatible hardware or software on your Local Area Network. Once your camera is setup on a LAN, you can utilize the NDI®|HX connection.

Two Easy Steps:

1. Download and install the latest NDI® Tools.
2. Select your camera within the NDI®|HX compatible device.

Step 1. Download and install the latest NDI®|HX Tools from <https://www.ndi.tv/tools>.

Step 2 (Optional). Configure your camera settings from the NDI Config tab in the camera's web interface.

Step 3. Select your camera. The NDI feed will utilize the camera's device friendly name.

NewTek®, NDI®, NDI® 4, & NDI®|HX are all registered trademarks by Vizrt Group®.

Please note that your NDI License key is non-transferrable.

IR Remote Controller Guide

To perform a command on the IR remote, press and release the button. A special note will be given when you can press and hold the button.

To perform a shortcut, press the buttons in a sequence when a right-angle bracket is shown. (>), or simultaneously when a plus sign (+) is shown.

1. Pan & Tilt Control

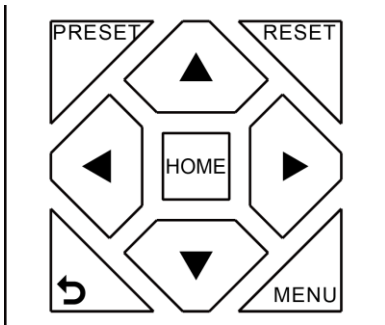

Tilt Up: Press [▲]
 Tilt Down: Press [▼]
 Pan Left: Press [◀]
 Pan Right: Press [▶]
 Face camera to front: Press [HOME]

Press and hold the Up / Down / Left / Right buttons to continue panning or tilting. The camera stops as soon as the button is released, or the limit is reached.

2. Zoom Control

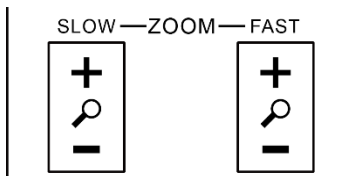

Zoom In: Press [+] Fast or Slow
 Zoom Out: Press [-] Fast or Slow

Press and hold the “-“ or “+“ button to continue zooming in or out. The zooming stops as soon as the button is released, or the limit is reached.

3. Focus Control

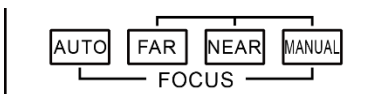

Auto Focus Mode: Press [AUTO]
 Manual Focus Mode: Press [MANUAL]
 Focus Far: Press [FAR]
 Focus Near: Press [NEAR]

Press and hold the “Near“ or “Far“ button to continue focusing in or out. The focusing stops as soon as the button is released, or the limit is reached.

4. Backlight, L/R Set, & P/T RST Controls

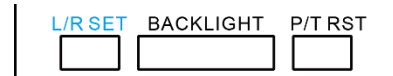

Reverse Pan Control: Press [L/R SET] + [1]
 Standard Pan Control: Press [L/R SET] + [2]
 Backlight Compensation: Press [BACKLIGHT]
 Self-Calibration Test: Press [P/T RST]

5. Presets – Setting, Calling, and Clearing

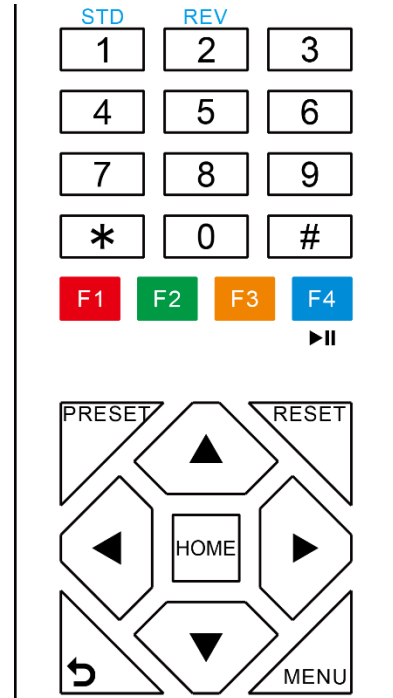

Set Preset: Press [PRESET] > preset number
 Call Preset: Press preset number
 Clear Preset: Press [RESET] > preset number
 Clear ALL Presets: Press [*] > [#] > [RESET]

Note: No action will be executed when calling a preset that has not yet been saved.

6. Image Freeze



Enable Image Freeze: Press [▶||]
 Disable Image Freeze: Press [▶||]

Note: After enabling / disabling Image Freeze, you will need to power cycle your camera to activate / deactivate the feature.

7. On Screen Display Menu Control

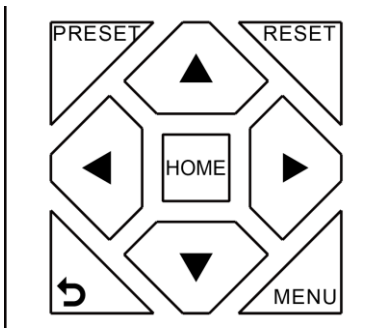

Open / Close OSD:	Press [MENU]
OSD Up:	Press [▲]
OSD Down:	Press [▼]
OSD Left:	Press [◀]
OSD Right:	Press [▶]
OSD Enter:	Press [HOME]
OSD Back:	Press [↶]

8. Change Camera IR Address



Address 1:	[*] > [#] > [F1]
Address 2:	[*] > [#] > [F2]
Address 3:	[*] > [#] > [F3]
Address 4:	[*] > [#] > [F4]

Note: Ensure that only one camera is 'listening' to the IR Address shortcut at a time. If multiple cameras receive the command, they will all change their IR address.

9. Camera Select

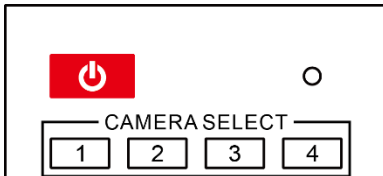

Control IR address 1:	Press [Cam Select 1]
Control IR address 2:	Press [Cam Select 2]
Control IR address 3:	Press [Cam Select 3]
Control IR address 4:	Press [Cam Select 4]

10. Standby Control



Enable Standby Mode:	Press [⏻]
Disable Standby Mode:	Press [⏻]

11. Camera Shortcuts

- [*] > [#] > [1]: Display OSD menu in English
- [*] > [#] > [3]: Display OSD menu in Chinese
- [*] > [#] > [4]: Show IP address
- [*] > [#] > [6]: Quickly restore the default settings
- [*] > [#] > [8]: Show the camera version
- [*] > [#] > [9]: Quickly set mount mode (flip / normal)
- [*] > [#] > [MANUAL]: Resets IP information to default
- [*] > [#] > [4]: Enable Dynamic IP address
- [L/R SET] + [1] (STD): Normal Pan controls
- [L/R SET] + [2] (REV): Reverses Pan controls
- [#] > [*] > [#] > [1]: Sets IP address to 192.168.100.81
- [#] > [*] > [#] > [2]: Sets IP address to 192.168.100.82
- [#] > [*] > [#] > [3]: Sets IP address to 192.168.100.83
- [#] > [*] > [#] > [4]: Sets IP address to 192.168.100.84
- [#] > [*] > [#] > [5]: Sets IP address to 192.168.100.85
- [#] > [*] > [#] > [6]: Sets IP address to 192.168.100.86
- [#] > [*] > [#] > [7]: Sets IP address to 192.168.100.87
- [#] > [*] > [#] > [8]: Sets IP address to 192.168.100.88
- [#] > [*] > [#] > [9]: Sets IP address to 192.168.100.89
- [#] > [*] > [#] > [0]: Sets IP address to 192.168.100.80

Dimensional Drawings (mm)

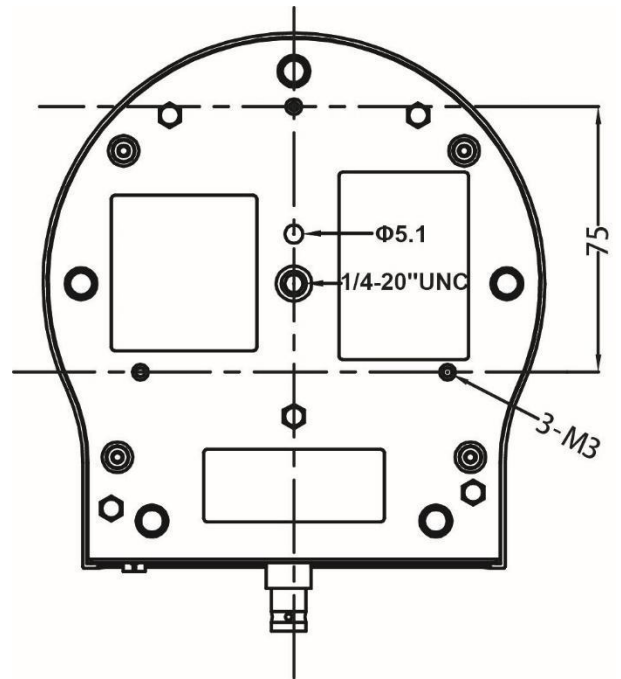
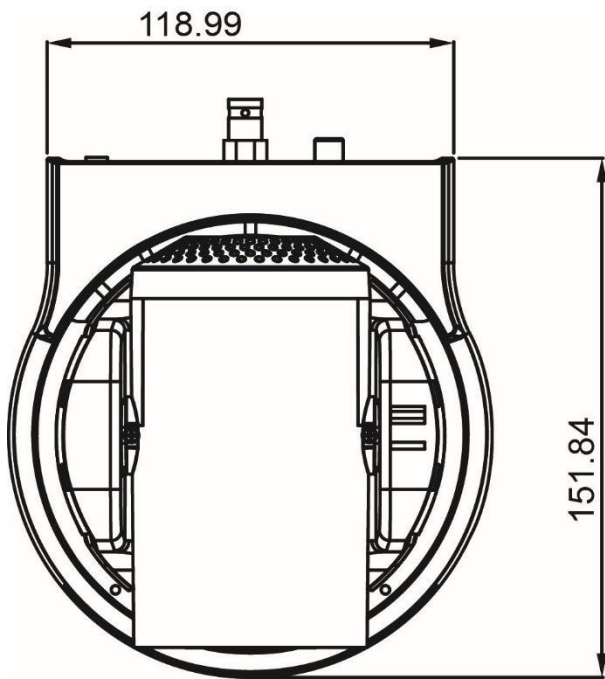
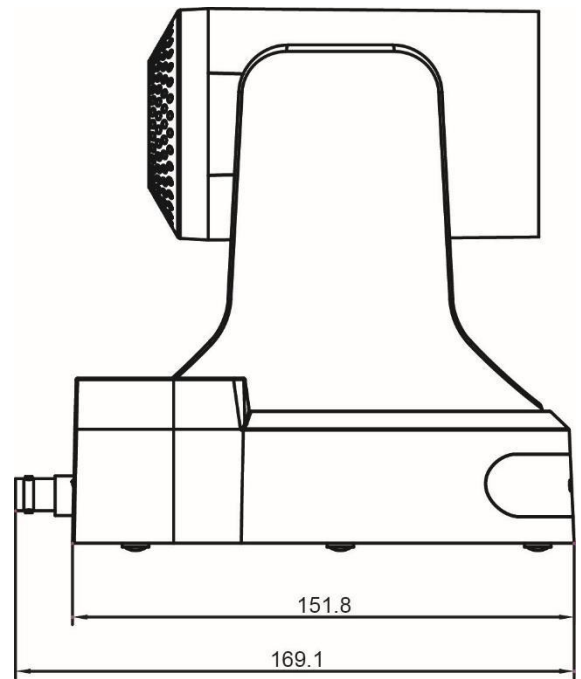
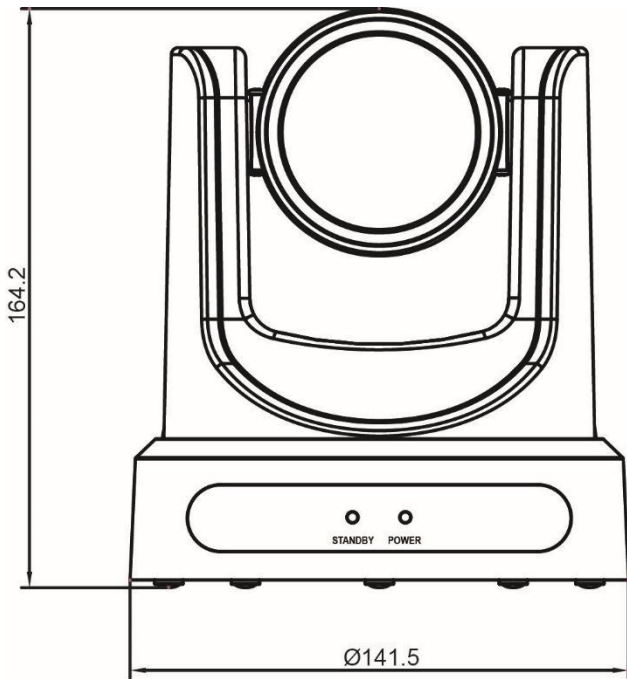

RS-232 Interface

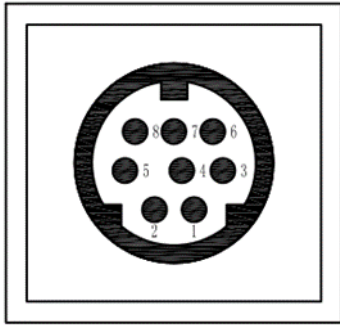

No.	Function
1	DTR
2	DSR
3	TXD
4	GND
5	RXD
6	GND
7	IR OUT
8	NC

For Initial Connection

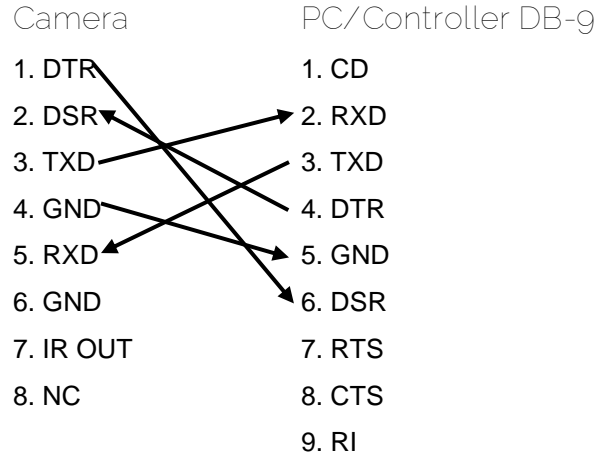

For Daisy Chain Control

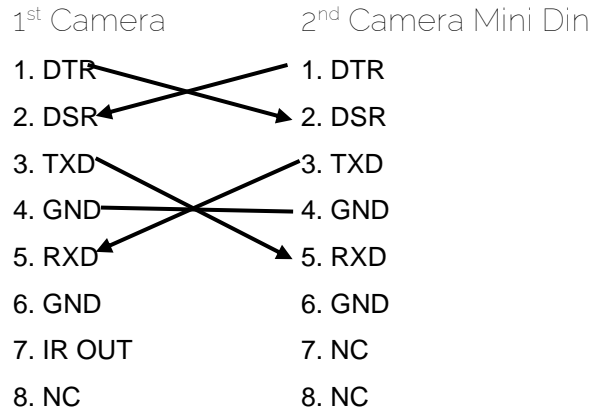

RS-485 Interface

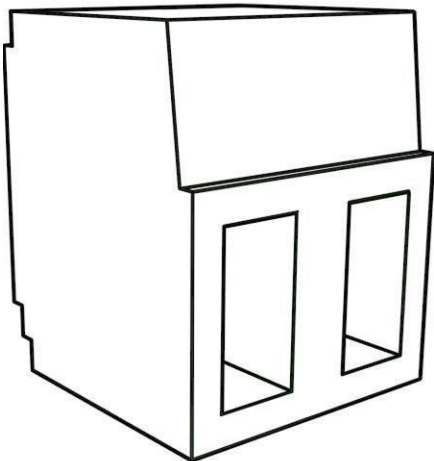

To utilize an RS-485 connection, you will need an unterminated two (2) conductor cable.

1. First, connect the positive (red) wire to the camera's positive phoenix connector port (left).
2. Then, connect the negative (black) wire to the camera's negative phoenix connector port (right).
3. Next, connect the positive and negative wires to the positive and negative ports on your joystick controller.
4. To connect multiple cameras, you have the option to connect via daisy-chain or home run.
5. In either method, multiple wires will be connected to a single phoenix connector port.

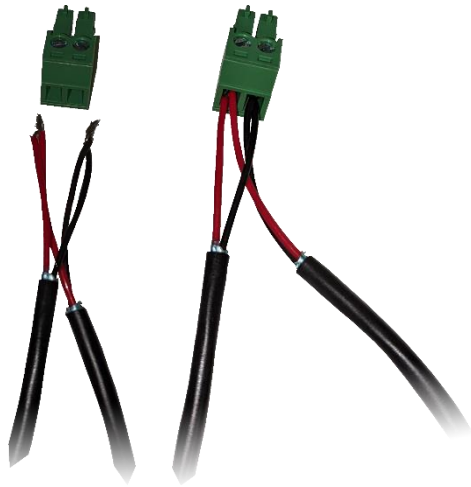

RS-485 Daisy-Chain connection

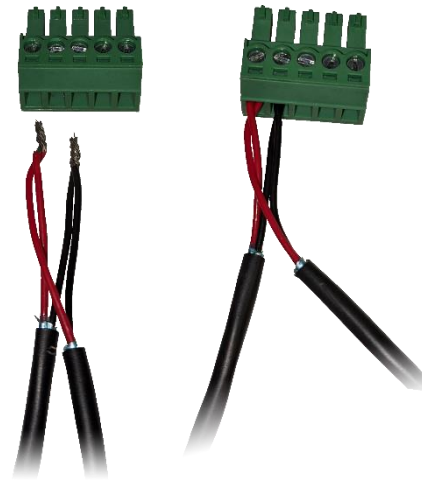

RS-485 Home Run connection

Serial Communication Control

In default working mode, the camera is able to connect to a VISCA controller with an RS-232 and/or RS-485 serial interface.

RS-232 Communication Control

The camera can be controlled via RS-232. The parameters for RS-232C are as follows:

Baud rate: 2400, 4800, 9600, or 38400 bps.
Start bit: 1 bit
Data bit: 8 bits.
Stop bit: 1 bit.
Parity Bit: none.

RS-485 Communication Control

The camera can be controlled via RS-485, Half-duplex mode, with support for VISCA, Pelco-D, or Pelco-P protocol. The parameters of RS485 are as follows:

Baud rate: 2400, 4800, 9600, or 38400 bps.
Start bit: 1 bit.
Data bit: 8 bits.
Stop bit: 1 bit.
Parity bit: none.

PTZOptics VISCA Command List

Part 1: Camera Issued Commands

ACK / Completion Messages			
Command	Function	Command Packet	Comments
ACK / Completion Messages	ACK	z0 4y FF (y: Socket No.)	Returned when the command is accepted.
	Completion	z0 5y FF (y: Socket No.)	Returned when the command has been executed.

Error Messages			
Command	Function	Command Packet	Comments
Error Messages	Syntax Error	z0 60 02 FF	Returned when the command format is different or when a command with illegal command parameters is accepted.
	Command Buffer Full	z0 60 03 FF	Indicates that two sockets are already being used (executing two commands) and the command could not be accepted when received
	Command Canceled	z0 6y 04 FF (y: Socket No.)	Returned when a command which is being executed in a socket specified by the cancel command is canceled. The completion message for the command is not returned.
	No Socket	z0 6y 05 FF (y: Socket No.)	Returned when no command is executed in a socket specified nu the cancel command, or when an invalid Socket No. is specified.
	Command Not Executable	z0 6y 41 FF (y: Execution command Socket No. Inquiry command: 0)	Returned when a command cannot be executed due to current conditions. For example: when commands controlling the focus manually are received during auto focus mode.

z = Camera Address + 8

Part 2: PTZOptics VISCA Command List

Command	Function	Command Packet	Comments
CAM_Power	On	8x 01 04 00 02 FF	Power On/Off
	Off	8x 01 04 00 03 FF	
CAM_Zoom	Stop	8x 01 04 07 00 FF	p = 0 (low) – 7 (high)
	Tele (Standard)	8x 01 04 07 02 FF	
	Wide (Standard)	8x 01 04 07 03 FF	
	Tele (Variable)	8x 01 04 07 2p FF	
	Wide (Variable)	8x 01 04 07 3p FF	
	Direct	8x 01 04 47 p q r s FF	
CAM_Focus	Stop	8x 01 04 08 00 FF	p = 0 (low) – 7 (high)
	Far (Standard)	8x 01 04 08 02 FF	
	Near (Standard)	8x 01 04 08 03 FF	
	Far (Variable)	8x 01 04 08 2p FF	
	Near (Variable)	8x 01 04 08 3p FF	
	Direct	8x 01 04 48 0p 0q 0r 0s FF	pqrs: Zoom Position (0x04 0x00 0x00 0x00 = Full Zoom in. 0x00 0x00 0x00 0x00 = Full Zoom out.)
	Auto Focus	8x 01 04 38 02 FF	Auto Focus On / Off
	Manual Focus	8x 01 04 38 03 FF	
	Auto / Manual	8x 01 04 38 10 FF	
	Focus Lock	8x 0a 04 68 02 FF	Prevents any other operation or command from adjusting the current focus state.
Focus Unlock	8x 0a 04 68 03 FF		
CAM_WB	Auto	8x 01 04 35 00 FF	Normal Auto mode
	Indoor	8x 01 04 35 01 FF	Indoor mode
	Outdoor	8x 01 04 35 02 FF	Outdoor mode
	OnePush	8x 01 04 35 03 FF	One Push White Balance mode
	Manual	8x 01 04 35 05 FF	Manual control mode
	ColorTemperature (VAR)	8x 01 04 35 20 FF	Color Temperature mode
CAM_RGain	OnePush Trigger	8x 01 04 10 05 FF	One Push White Balance Trigger
	Reset	8x 01 04 03 00 FF	Manual control of red gain
	Up	8x 01 04 03 02 FF	
	Down	8x 01 04 03 03 FF	
Direct	8x 01 04 43 00 00 0p 0q FF	pq: Red Gain	
CAM_BGain	Reset	8x 01 04 04 00 FF	Manual control of blue gain
	Up	8x 01 04 04 02 FF	
	Down	8x 01 04 04 03 FF	
	Direct	8x 01 04 44 00 00 0p 0q FF	pq: Blue Gain
CAM_ColorTemp	Reset	8x 01 04 20 00 FF	Default ColorTemperature settings
	Up	8x 01 04 20 02 FF	
	Down	8x 01 04 20 03 FF	
	Direct	8x 01 04 20 0p 0q FF	pq: ColorTemperature position: 0x00: 2500K ~ 0x37: 8000K
CAM_AE	Full Auto	8x 01 04 39 00 FF	Automatic Exposure mode
	Manual	8x 01 04 39 03 FF	Manual exposure mode
	Shutter Priority	8x 01 04 39 0A FF	Shutter priority auto exposure mode
	Iris Priority	8x 01 04 39 0B FF	Iris priority auto exposure mode
	Bright	8x 01 04 39 0D FF	Bright manual exposure mode
CAM_Iris	Reset	8x 01 04 0B 00 FF	Default Iris position
	Up	8x 01 04 0B 02 FF	Iris setting
	Down	8x 01 04 0B 03 FF	
	Direct	8x 01 04 4B 00 00 0p 0q FF	pq: Iris position
CAM_Shutter	Reset	8x 01 04 0A 00 FF	Default shutter position
	Up	8x 01 04 0A 02 FF	Shutter setting
	Down	8x 01 04 0A 03 FF	
	Direct	8x 01 04 4A 00 00 0p 0q FF	pq: Shutter position
CAM_Bright	Reset	8x 01 04 0D 00 FF	Default Bright position
	Up	8x 01 04 0D 02 FF	Bright setting
	Down	8x 01 04 0D 03 FF	
	Direct	8x 01 04 0D 00 00 0p 0q FF	pq: Bright position
CAM_ExpComp	On	8x 01 04 3E 02 FF	Exposure Compensation On / Off
	Off	8x 01 04 3E 03 FF	
	Reset	8x 01 04 0E 00 FF	Default ExpComp position

	Up	8x 01 04 0E 02 FF	ExpComp setting
	Down	8x 01 04 0E 03 FF	
	Direct	8x 01 04 4E 00 00 0p 0q FF	
CAM_Backlight	On	8x 01 04 33 02 FF	Backlight Compensation On / Off
	Off	8x 01 04 33 03 FF	
CAM_Flicker		8x 01 04 23 0p FF	p: Flicker settings - (0: Off, 1: 50Hz, 2: 60Hz)
CAM_Picture Effect	Off	8x 01 04 63 00 FF	Picture Effect setting
	B&W	8x 01 04 63 04 FF	
CAM_Memory	Reset	8x 01 04 3F 00 pp FF	pp: Memory number (=0 to 127)
	Set	8x 01 04 3F 01 pp FF	
	Recall	8x 01 04 3F 02 pp FF	
Preset_Recall_Speed	Preset Speed	8x 01 06 01 p FF	P: Speed grade (0x01 ~ 0x18)
CAM_LR_Reverse	On	8x 01 04 61 02 FF	Image Flip Horizontal On / Off
	Off	8x 01 04 61 03 FF	
CAM_PictureFlip	On	8x 01 04 66 02 FF	Image Flip Vertical On / Off
	Off	8x 01 04 66 03 FF	
CAM_ColorGain	Direct	8x 01 04 49 00 00 00 0p FF	P: Color Gain setting 0h (60%) to Eh(200%)
Pan_TiltDrive	Up	8x 01 06 01 VV WW 03 01 FF	VV: Pan Speed 0x01 (low) to 0x18 (high) WW: Tilt Speed 0x01 (low) to 0x14 (high)
	Down	8x 01 06 01 VV WW 03 02 FF	
	Left	8x 01 06 01 VV WW 01 03 FF	
	Right	8x 01 06 01 VV WW 02 03 FF	
	UpLeft	8x 01 06 01 VV WW 01 01 FF	
	UpRight	8x 01 06 01 VV WW 02 01 FF	
	DownLeft	8x 01 06 01 VV WW 01 02 FF	
	DownRight	8x 01 06 01 VV WW 02 02 FF	
	Stop	8x 01 06 01 VV WW 03 03 FF	
	AbsolutePosition	8x 01 06 02 VV WW 0Y 0Y 0Y 0Y 0Z 0Z 0Z 0Z FF	YYYY: Pan position, ZZZZ: Tilt position
	RelativePosition	8x 01 06 03 VV WW 0Y 0Y 0Y 0Y 0Z 0Z 0Z 0Z FF	
Home	8x 01 06 04 FF		
Reset	8x 01 06 05 FF		
Pan_TiltLimitSet	LimitSet	8x 01 06 07 00 0W 0Y 0Y 0Y 0Y 0Z 0Z 0Z 0Z FF	W: 1 (UpRight), 0: DownLeft YYYY: Pan position, ZZZZ: Tilt position
	LimitClear	8x 01 06 07 01 0W 07 0F 0F 0F 07 0F 0F 0F FF	
CAM_Brightness	Direct	8x 01 04 A1 00 00 0p 0q FF	pq: Brightness position
CAM_Contrast	Direct	8x 01 04 A2 00 00 0p 0q FF	pq: Contrast position
CAM_Flip	Off	8x 01 04 A4 00 FF	Single Command for video flip
	Flip-H	8x 01 04 A4 01 FF	
	Flip-V	8x 01 04 A4 02 FF	
	Flip-HV	8x 01 04 A4 03 FF	
CAM_SettingSave	Save	8x 01 04 A5 10 FF	Save Current Setting
CAM_AWB Sensitivity	High	8x 01 04 A9 00 FF	
	Normal	8x 01 04 A9 01 FF	
	Low	8x 01 04 A9 02 FF	
CAM_AFZone	Top	8x 01 04 AA 00 FF	AF Zone weight select
	Center	8x 01 04 AA 01 FF	
	Bottom	8x 01 04 AA 02 FF	
CAM_ColorHue	Direct	8x 01 04 4F 00 00 00 0p FF	P: Color Hue setting 0h (-14°) to Eh (+14°)
OSD_Control	Open / Close	8x 01 04 3F 02 5F FF	
	Navigate Up	8x 01 06 01 0E 0E 03 01 FF	
	Navigate Down	8x 01 06 01 0E 0E 03 02 FF	
	Navigate Left	8x 01 06 01 0E 0E 01 03 FF	
	Navigate Right	8x 01 06 01 0E 0E 02 03 FF	
	Enter	8x 01 06 06 05 FF	
	Return	8x 01 06 06 04 FF	
CAM_NDIMode	High	8x 0B 01 01 FF	
	Medium	8x 0B 01 02 FF	
	Low	8x 0B 01 03 FF	
	Off	8x 0B 01 04 FF	

CAM_Multicast Mode	Multicast Mode	8x 0B 01 23 0p FF	p=1: On, p=2: Off
CAM_PTZMotion Sync	PTZ Motion Sync On	8x 0A 11 13 02 FF	
	PTZ Motion Sync Off	8x 0A 11 13 03 FF	
	PTZ MS Upper Speed Limit	8x 0A 11 14 pq FF	pq: Speed stage
	PTZ MS Lower Speed Limit	8x 0A 11 14 pq FF	
CAM_UACStatus	Toggle USB Audio	8x 2a 02 a0 04 0p FF	p=2: On, p=3: Off

x = Camera Address + 8

Part 3: PTZOptics VISCA Query Command List

CAM_PowerInq	8x 09 04 00 FF	y0 50 02 FF	On
		y0 50 03 FF	Off (Standby)
		y0 50 04 FF	Internal Power Circuit Error
CAM_ZoomPosInq	8x 09 04 47 FF	y0 50 0p 0q 0r 0s FF	pqrs: Zoom position
CAM_FocusAFModelInq	8x 09 04 38 FF	y0 50 02 FF	Auto Focus
		y0 50 03 FF	Manual Focus
CAM_FocusPosInq	8x 09 04 48 FF	y0 50 0p 0q 0r 0s FF	pqrs: Focus Position
CAM_WBModelInq	8x 09 04 35 FF	y0 50 00 FF	Auto
		y0 50 01 FF	Indoor
		y0 50 02 FF	Outdoor
		y0 50 03 FF	OnePush
		y0 50 05 FF	Manual
		y0 50 20 FF	ColorTemperature
CAM_RGainInq	8x 09 04 43 FF	y0 50 00 00 0p 0q FF	pq: Red Gain
CAM_BGainInq	8x 09 04 44 FF	y0 50 00 00 0p 0q FF	pq: Blue Gain
CAM_ColorTempInq	8x 09 04 20 FF	y0 50 pq FF	pq: ColorTemperature position
CAM_AEModelInq	8x 09 04 39 FF	y0 50 00 FF	Full Auto
		y0 50 03 FF	Manual
		y0 50 0A FF	Shutter Priority (SAE)
		y0 50 0B FF	Iris Priority (AAE)
		y0 50 0D FF	Bright
CAM_ShutterPosInq	8x 09 04 4A FF	y0 50 00 00 0p 0q FF	pq: Shutter position
CAM_IrisPosInq	8x 09 04 4B FF	y0 50 00 00 0p 0q FF	pq: Iris position
CAM_BrightPosInq	8x 09 04 4D FF	y0 50 00 00 0p 0q FF	pq: Bright position
CAM_ExpCompModelInq	8x 09 04 3E FF	y0 50 02 FF	On
		y0 50 03 FF	Off
CAM_ExpCompPosInq	8x 09 04 4E FF	y0 50 00 00 0p 0q FF	pq: ExpComp position
CAM_BacklightModelInq	8x 09 04 33 FF	y0 50 02 FF	On
		y0 50 03 FF	Off
CAM_Noise2DModelInq	8x 09 04 50 FF	y0 50 02 FF	Auto Noise 2D
		y0 50 03 FF	Manual Noise 2D
CAM_Noise2DLevel	8x 09 04 53 FF	y0 50 0p FF	Noise Reduction (2D) p: 0 to 5
CAM_Noise3DLevel	8x 09 04 54 FF	y0 50 0p FF	Noise Reduction (3D) p: 0 to 5
CAM_FlickerModelInq	8x 09 04 55 FF	y0 50 0p FF	p=0: Off, 1: 50Hz, 2: 60Hz
CAM_ApertureModelInq (Sharpness)	8x 09 04 05 FF	y0 50 02 FF	Auto Sharpness
		y0 50 03 FF	Manual Sharpness
CAM_ApertureInq (Sharpness)	8x 09 04 42 FF	y0 50 00 00 0p 0q FF	pq: Aperture gain
SYS_MenuModelInq	8x 09 06 06 FF	y0 50 02 FF	On
		y0 50 03 FF	Off
CAM_PictureEffectModelInq	8x 09 04 63 FF	y0 50 02 FF	Off
		y0 50 04 FF	B&W
CAM_LR_ReverseInq	8x 09 04 61 FF	y0 50 02 FF	On
		y0 50 03 FF	Off
CAM_PictureFlipInq	8x 09 04 66 FF	y0 50 02 FF	On
		y0 50 03 FF	Off
CAM_ColorGainInq	8x 09 04 49 FF	y0 50 00 00 00 0p FF	P: Color gain 0h (60%) to Eh (200%)
CAM_PanTiltPosInq	8x 09 06 12 FF	y0 50 0w 0w 0w 0w 0z 0z 0z 0z FF	WWWW: Pan position, ZZZZ: Tilt position
CAM_GainLimitInq	8x 09 04 2C FF	y0 50 0q FF	p: Gain limit
CAM_AFSensitivityInq	8x 09 04 58 FF	y0 50 01 FF	High
		y0 50 02 FF	Normal
		y0 50 03 FF	Low
CAM_BrightnessInq	8x 09 04 A1 FF	y0 50 00 00 0p 0q FF	pq: Brightness position

CAM_ContrastInq	8x 09 04 A2 FF	y0 50 00 00 0p 0q FF	pg: Contrast position
CAM_FlipInq	8x 09 04 A4 FF	y0 50 00 FF	Off
		y0 50 01 FF	Flip-H
		y0 50 02 FF	Flip-V
		y0 50 03 FF	Flip-HV
CAM_AFZone	8x 09 04 AA FF	y0 50 00 FF	Top
		y0 50 01 FF	Center
		y0 50 02 FF	Bottom
CAM_ColorHueInq	8x 09 04 4F FF	y0 50 00 00 00 0p FF	P: Color Hue 0h (-14°) to Eh (+14°)
CAM_AWBSensitivityInq	8x 09 04 A9 FF	y0 50 00 FF	High
		y0 50 01 FF	Normal
		y0 50 02 FF	Low
CAM_UACInq	8x 2A 02 A0 04 FF	y0 50 02 FF	On
		y0 50 03 FF	Off

Block Inquiry Command List			
Command	Command Packet	Inquiry Packet	Comments
CAM_LensBlockInq	8x 09 7E 7E 00 FF	y0 50 0u 0u 0u 0u 00 00 0v 0v 0v 0v 00 0w 00 FF	UUUU: Zoom position VVVV: Focus position W.bit0: Focus mode 1: Auto, 0: manual
CAM_CameraBlockInq	8x 09 7E 7E 01 FF	y0 50 0p 0p 0q 0q 0r 0s tt 0u vv ww 00 xx 0z FF	PP: Red Gain, QQ: Blue Gain R: WB Mode, S: Aperture TT: AE Mode, U.bit2: Backlight U.bit1: Exposure Comp, VV: Shutter position. WW: Iris position, XX Bright position, Z: Exposure Comp position
CAM_OtherBlockInq	8x 09 7E 7E 02 FF	y0 50 0p 0q 00 0r 00 00 00 00 00 00 00 00 00 FF	P.bit0: Power 1: On, 0: Off Q.bit2: LR Reverse: 1: On, 0: Off R.bit3~0: Picture Effect Mode
CAM_EnlargmentBlockInq	8x 09 7E 7E 03 FF	y0 50 00 00 00 00 00 00 00 0p 0q rr 0s 0t 0u FF	P: AF sensitivity Q.bit0: Picture flip: 1: On, 0: Off RR.bit6~3: Color Gain (0h (60%) to Eh (200%)) S: Flip 0: Off, 1: Flip-H, 2: FlipV, 3: Flip-HV T.bit2~0: NR2D level U: Gain limit

y = (x + 8) - X = VISCA Address

Part 4: PTZOptics VISCA over IP Command List

Command	Function	Command Packet	Comments
CAM_Power	On	81 01 04 00 02 FF	Power On/Off
	Off	81 01 04 00 03 FF	
CAM_Zoom	Stop	81 01 04 07 00 FF	p = 0 (low) – 7 (high)
	Tele (Standard)	81 01 04 07 02 FF	
	Wide (Standard)	81 01 04 07 03 FF	
	Tele (Variable)	81 01 04 07 2p FF	
	Wide (Variable)	81 01 04 07 3p FF	
	Direct	81 01 04 47 p q r s FF	
CAM_Focus	Stop	81 01 04 08 00 FF	p = 0 (low) – 7 (high)
	Far (Standard)	81 01 04 08 02 FF	
	Near (Standard)	81 01 04 08 03 FF	
	Far (Variable)	81 01 04 08 2p FF	
	Near (Variable)	81 01 04 08 3p FF	
	Direct	81 01 04 48 0p 0q 0r 0s FF	pqrs: Zoom Position (0x04 0x00 0x00 0x00 = Full Zoom in. 0x00 0x00 0x00 0x00 = Full Zoom out.)
	Auto Focus	81 01 04 38 02 FF	Auto Focus On / Off
	Manual Focus	81 01 04 38 03 FF	
	Auto / Manual	81 01 04 38 10 FF	
	Focus Lock	81 0a 04 68 02 FF	Prevents any other operation or command from adjusting the current focus state.
Focus Unlock	81 0a 04 68 03 FF		
CAM_WB	Auto	81 01 04 35 00 FF	Normal Auto mode
	Indoor	81 01 04 35 01 FF	Indoor mode
	Outdoor	81 01 04 35 02 FF	Outdoor mode
	OnePush	81 01 04 35 03 FF	One Push White Balance mode
	Manual	81 01 04 35 05 FF	Manual control mode
	ColorTemperature (VAR)	81 01 04 35 20 FF	Color Temperature mode
CAM_RGain	OnePush Trigger	81 01 04 10 05 FF	One Push White Balance Trigger
	Reset	81 01 04 03 00 FF	Manual control of red gain
	Up	81 01 04 03 02 FF	
	Down	81 01 04 03 03 FF	
Direct	81 01 04 43 00 00 0p 0q FF	pq: Red Gain	
CAM_BGain	Reset	81 01 04 04 00 FF	Manual control of blue gain
	Up	81 01 04 04 02 FF	
	Down	81 01 04 04 03 FF	
	Direct	81 01 04 44 00 00 0p 0q FF	pq: Blue Gain
CAM_ColorTemp	Reset	81 01 04 20 00 FF	Default ColorTemperature settings
	Up	81 01 04 20 02 FF	
	Down	81 01 04 20 03 FF	
	Direct	81 01 04 20 0p 0q FF	pq: ColorTemperature position: 0x00: 2500K ~ 0x37: 8000K
CAM_AE	Full Auto	81 01 04 39 00 FF	Automatic Exposure mode
	Manual	81 01 04 39 03 FF	Manual exposure mode
	Shutter Priority	81 01 04 39 0A FF	Shutter priority auto exposure mode
	Iris Priority	81 01 04 39 0B FF	Iris priority auto exposure mode
	Bright	81 01 04 39 0D FF	Bright manual exposure mode
CAM_Iris	Reset	81 01 04 0B 00 FF	Default Iris position
	Up	81 01 04 0B 02 FF	Iris setting
	Down	81 01 04 0B 03 FF	
	Direct	81 01 04 4B 00 00 0p 0q FF	pq: Iris position
CAM_Shutter	Reset	81 01 04 0A 00 FF	Default shutter position
	Up	81 01 04 0A 02 FF	Shutter setting
	Down	81 01 04 0A 03 FF	
	Direct	81 01 04 4A 00 00 0p 0q FF	pq: Shutter position
CAM_Bright	Reset	81 01 04 0D 00 FF	Default Bright position
	Up	81 01 04 0D 02 FF	Bright setting
	Down	81 01 04 0D 03 FF	
	Direct	81 01 04 0D 00 00 0p 0q FF	pq: Bright position
CAM_ExpComp	On	81 01 04 3E 02 FF	Exposure Compensation On / Off
	Off	81 01 04 3E 03 FF	
	Reset	81 01 04 0E 00 FF	Default ExpComp position

	Up	81 01 04 0E 02 FF	ExpComp setting
	Down	81 01 04 0E 03 FF	
	Direct	81 01 04 4E 00 00 0p 0q FF	
CAM_Backlight	On	81 01 04 33 02 FF	Backlight Compensation On / Off
	Off	81 01 04 33 03 FF	
CAM_Flicker		81 01 04 23 0p FF	p: Flicker settings - (0: Off, 1: 50Hz, 2: 60Hz)
CAM_Picture Effect	Off	81 01 04 63 00 FF	Picture Effect setting
	B&W	81 01 04 63 04 FF	
CAM_Memory	Reset	81 01 04 3F 00 pp FF	pp: Memory number (=0 to 127)
	Set	81 01 04 3F 01 pp FF	
	Recall	81 01 04 3F 02 pp FF	
Preset_Recall_Speed	Preset Speed	81 01 06 01 p FF	P: Speed grade (0x01 ~ 0x18)
CAM_LR_Reverse	On	81 01 04 61 02 FF	Image Flip Horizontal On / Off
	Off	81 01 04 61 03 FF	
CAM_PictureFlip	On	81 01 04 66 02 FF	Image Flip Vertical On / Off
	Off	81 01 04 66 03 FF	
CAM_ColorGain	Direct	81 01 04 49 00 00 00 0p FF	P: Color Gain setting 0h (60%) to Eh(200%)
Pan_TiltDrive	Up	81 01 06 01 VV WW 03 01 FF	VV: Pan Speed 0x01 (low) to 0x18 (high) WW: Tilt Speed 0x01 (low) to 0x14 (high)
	Down	81 01 06 01 VV WW 03 02 FF	
	Left	81 01 06 01 VV WW 01 03 FF	
	Right	81 01 06 01 VV WW 02 03 FF	
	UpLeft	81 01 06 01 VV WW 01 01 FF	
	UpRight	81 01 06 01 VV WW 02 01 FF	
	DownLeft	81 01 06 01 VV WW 01 02 FF	
	DownRight	81 01 06 01 VV WW 02 02 FF	
	Stop	81 01 06 01 VV WW 03 03 FF	YYYY: Pan position, ZZZZ: Tilt position
	AbsolutePosition	81 01 06 02 VV WW 0Y 0Y 0Y 0Y 0Z 0Z 0Z 0Z FF	
	RelativePosition	81 01 06 03 VV WW 0Y 0Y 0Y 0Y 0Z 0Z 0Z 0Z FF	
Home	81 01 06 04 FF		
Reset	81 01 06 05 FF		
Pan_TiltLimitSet	LimitSet	81 01 06 07 00 0W 0Y 0Y 0Y 0Y 0Z 0Z 0Z 0Z FF	W: 1 (UpRight), 0: DownLeft YYYY: Pan position, ZZZZ: Tilt position
	LimitClear	81 01 06 07 01 0W 07 0F 0F 0F 07 0F 0F 0F FF	
CAM_Brightness	Direct	81 01 04 A1 00 00 0p 0q FF	pq: Brightness position
CAM_Contrast	Direct	81 01 04 A2 00 00 0p 0q FF	pq: Contrast position
CAM_Flip	Off	81 01 04 A4 00 FF	Single Command for video flip
	Flip-H	81 01 04 A4 01 FF	
	Flip-V	81 01 04 A4 02 FF	
	Flip-HV	81 01 04 A4 03 FF	
CAM_SettingSave	Save	81 01 04 A5 10 FF	Save Current Setting
CAM_AWB Sensitivity	High	81 01 04 A9 00 FF	
	Normal	81 01 04 A9 01 FF	
	Low	81 01 04 A9 02 FF	
CAM_AFZone	Top	81 01 04 AA 00 FF	AF Zone weight select
	Center	81 01 04 AA 01 FF	
	Bottom	81 01 04 AA 02 FF	
CAM_ColorHue	Direct	81 01 04 4F 00 00 00 0p FF	P: Color Hue setting 0h (-14°) to Eh (+14°)
OSD_Control	Open / Close	81 01 04 3F 02 5F FF	
	Navigate Up	81 01 06 01 0E 0E 03 01 FF	
	Navigate Down	81 01 06 01 0E 0E 03 02 FF	
	Navigate Left	81 01 06 01 0E 0E 01 03 FF	
	Navigate Right	81 01 06 01 0E 0E 02 03 FF	
	Enter	81 01 06 06 05 FF	
	Return	81 01 06 06 04 FF	
CAM_NDIMode	High	81 0B 01 01 FF	
	Medium	81 0B 01 02 FF	
	Low	81 0B 01 03 FF	
	Off	81 0B 01 04 FF	

CAM_Multicast Mode	Multicast Mode	81 0B 01 23 0p FF	p=1: On, p=2: Off
CAM_PTZMotion Sync	PTZ Motion Sync On	81 0A 11 13 02 FF	
	PTZ Motion Sync Off	81 0A 11 13 03 FF	
	PTZ MS Upper Speed Limit	81 0A 11 14 pq FF	pq: Speed stage
	PTZ MS Lower Speed Limit	81 0A 11 14 pq FF	
CAM_UACStatus	Toggle USB Audio	81 2a 02 a0 04 0p FF	p=2: On, p=3: Off

Part 5: PTZOptics VISCA over IP Query Command List

CAM_PowerInq	81 09 04 00 FF	y0 50 02 FF	On
		y0 50 03 FF	Off (Standby)
		y0 50 04 FF	Internal Power Circuit Error
CAM_ZoomPosInq	81 09 04 47 FF	y0 50 0p 0q 0r 0s FF	pqrs: Zoom position
CAM_FocusAFModelInq	81 09 04 38 FF	y0 50 02 FF	Auto Focus
		y0 50 03 FF	Manual Focus
CAM_FocusPosInq	81 09 04 48 FF	y0 50 0p 0q 0r 0s FF	pqrs: Focus Position
CAM_WBModelInq	81 09 04 35 FF	y0 50 00 FF	Auto
		y0 50 01 FF	Indoor
		y0 50 02 FF	Outdoor
		y0 50 03 FF	OnePush
		y0 50 05 FF	Manual
		y0 50 20 FF	ColorTemperature
CAM_RGainInq	81 09 04 43 FF	y0 50 00 00 0p 0q FF	pq: Red Gain
CAM_BGainInq	81 09 04 44 FF	y0 50 00 00 0p 0q FF	pq: Blue Gain
CAM_ColorTempInq	81 09 04 20 FF	y0 50 pq FF	pq: ColorTemperature position
CAM_AEModelInq	81 09 04 39 FF	y0 50 00 FF	Full Auto
		y0 50 03 FF	Manual
		y0 50 0A FF	Shutter Priority (SAE)
		y0 50 0B FF	Iris Priority (AAE)
		y0 50 0D FF	Bright
CAM_ShutterPosInq	81 09 04 4A FF	y0 50 00 00 0p 0q FF	pq: Shutter position
CAM_IrisPosInq	81 09 04 4B FF	y0 50 00 00 0p 0q FF	pq: Iris position
CAM_BrightPosInq	81 09 04 4D FF	y0 50 00 00 0p 0q FF	pq: Bright position
CAM_ExpCompModelInq	81 09 04 3E FF	y0 50 02 FF	On
		y0 50 03 FF	Off
CAM_ExpCompPosInq	81 09 04 4E FF	y0 50 00 00 0p 0q FF	pq: ExpComp position
CAM_BacklightModelInq	81 09 04 33 FF	y0 50 02 FF	On
		y0 50 03 FF	Off
CAM_Noise2DModelInq	81 09 04 50 FF	y0 50 02 FF	Auto Noise 2D
		y0 50 03 FF	Manual Noise 2D
CAM_Noise2DLevel	81 09 04 53 FF	y0 50 0p FF	Noise Reduction (2D) p: 0 to 5
CAM_Noise3DLevel	81 09 04 54 FF	y0 50 0p FF	Noise Reduction (3D) p: 0 to 5
CAM_FlickerModelInq	81 09 04 55 FF	y0 50 0p FF	p=0: Off, 1: 50Hz, 2: 60Hz
CAM_ApertureModelInq (Sharpness)	81 09 04 05 FF	y0 50 02 FF	Auto Sharpness
		y0 50 03 FF	Manual Sharpness
CAM_ApertureInq (Sharpness)	81 09 04 42 FF	y0 50 00 00 0p 0q FF	pq: Aperture gain
SYS_MenuModelInq	81 09 06 06 FF	y0 50 02 FF	On
		y0 50 03 FF	Off
CAM_PictureEffectModelInq	81 09 04 63 FF	y0 50 02 FF	Off
		y0 50 04 FF	B&W
CAM_LR_ReverseInq	81 09 04 61 FF	y0 50 02 FF	On
		y0 50 03 FF	Off
CAM_PictureFlipInq	81 09 04 66 FF	y0 50 02 FF	On
		y0 50 03 FF	Off
CAM_ColorGainInq	81 09 04 49 FF	y0 50 00 00 00 0p FF	P: Color gain 0h (60%) to Eh (200%)
CAM_PanTiltPosInq	81 09 06 12 FF	y0 50 0w 0w 0w 0w 0z 0z 0z 0z FF	WWWW: Pan position, ZZZZ: Tilt position
CAM_GainLimitInq	81 09 04 2C FF	y0 50 0q FF	p: Gain limit
CAM_AFSensitivityInq	81 09 04 58 FF	y0 50 01 FF	High
		y0 50 02 FF	Normal
		y0 50 03 FF	Low
CAM_BrightnessInq	81 09 04 A1 FF	y0 50 00 00 0p 0q FF	pq: Brightness position

CAM_ContrastInq	81 09 04 A2 FF	y0 50 00 00 0p 0q FF	pq: Contrast position
CAM_FlipInq	81 09 04 A4 FF	y0 50 00 FF	Off
		y0 50 01 FF	Flip-H
		y0 50 02 FF	Flip-V
		y0 50 03 FF	Flip-HV
CAM_AFZone	81 09 04 AA FF	y0 50 00 FF	Top
		y0 50 01 FF	Center
		y0 50 02 FF	Bottom
CAM_ColorHueInq	81 09 04 4F FF	y0 50 00 00 00 0p FF	P: Color Hue 0h (-14°) to Eh (+14°)
CAM_AWBSensitivityInq	81 09 04 A9 FF	y0 50 00 FF	High
		y0 50 01 FF	Normal
		y0 50 02 FF	Low
CAM_UACInq	81 2A 02 A0 04 FF	y0 50 02 FF	On
		y0 50 03 FF	Off

Block Inquiry Command List			
Command	Command Packet	Inquiry Packet	Comments
CAM_LensBlockInq	81 09 7E 7E 00 FF	y0 50 0u 0u 0u 0u 00 00 0v 0v 0v 0v 00 0w 00 FF	UUUU: Zoom position VVVV: Focus position W.bit0: Focus mode 1: Auto, 0: manual
CAM_CameraBlockInq	81 09 7E 7E 01 FF	y0 50 0p 0p 0q 0q 0r 0s tt 0u vv ww 00 xx 0z FF	PP: Red Gain, QQ: Blue Gain R: WB Mode, S: Aperture TT: AE Mode, U.bit2: Backlight U.bit1: Exposure Comp, VV: Shutter position. WW: Iris position, XX Bright position, Z: Exposure Comp position
CAM_OtherBlockInq	81 09 7E 7E 02 FF	y0 50 0p 0q 00 0r 00 00 00 00 00 00 00 00 00 FF	P.bit0: Power 1: On, 0: Off Q.bit2: LR Reverse: 1: On, 0: Off R.bit3~0: Picture Effect Mode
CAM_EnlargmentBlockInq	81 09 7E 7E 03 FF	y0 50 00 00 00 00 00 00 00 0p 0q rr 0s 0t 0u FF	P: AF sensitivity Q.bit0: Picture flip: 1: On, 0: Off RR.bit6~3: Color Gain (0h (60%) to Eh (200%)) S: Flip 0: Off, 1: Flip-H, 2: FlipV, 3: Flip-HV T.bit2~0: NR2D level U: Gain limit

Part 6: Pelco-D Protocol Command List

Function	Byte1	Byte2	Byte3	Byte4	Byte5	Byte6	Byte7
Up	0xFF	Address	0x00	0x08	Pan Speed	Tilt Speed	SUM
Down	0xFF	Address	0x00	0x10	Pan Speed	Tilt Speed	SUM
Left	0xFF	Address	0x00	0x04	Pan Speed	Tilt Speed	SUM
Right	0xFF	Address	0x00	0x02	Pan Speed	Tilt Speed	SUM
Zoom In	0xFF	Address	0x00	0x20	0x00	0x00	SUM
Zoom Out	0xFF	Address	0x00	0x40	0x00	0x00	SUM
Focus Far	0xFF	Address	0x00	0x80	0x00	0x00	SUM
Focus Near	0xFF	Address	0x00	0x00	0x00	0x00	SUM
Set Preset	0xFF	Address	0x00	0x03	0x00	Preset ID	SUM
Clear Preset	0xFF	Address	0x00	0x05	0x00	Preset ID	SUM
Call Preset	0xFF	Address	0x00	0x07	0x00	Preset ID	SUM
Auto Focus	0xFF	Address	0x00	0x2B	0x00	0x01	SUM
Manual Focus	0xFF	Address	0x00	0x2B	0x00	0x02	SUM
Query Pan Position	0xFF	Address	0x00	0x51	0x00	0x00	SUM
Query Pan Position Response	0xFF	Address	0x00	0x59	Value High Byte	Value Low Byte	SUM
Query Tilt Position	0xFF	Address	0x00	0x53	0x00	0x00	SUM
Query Tilt Position Response	0xFF	Address	0x00	0x5B	Value High Byte	Value Low Byte	SUM
Query Zoom Position	0xFF	Address	0x00	0x55	0x00	0x00	SUM
Query Zoom Position Response	0xFF	Address	0x00	0x5D	Value High Byte	Value Low Byte	SUM

Part 7: Pelco-P Protocol Command List

Function	Byte1	Byte2	Byte3	Byte4	Byte5	Byte6	Byte7	Byte8
Up	0xA0	Address	0x00	0x08	Pan Speed	Tilt Speed	0xAF	XOR
Down	0xA0	Address	0x00	0x10	Pan Speed	Tilt Speed	0xAF	XOR
Left	0xA0	Address	0x00	0x04	Pan Speed	Tilt Speed	0xAF	XOR
Right	0xA0	Address	0x00	0x02	Pan Speed	Tilt Speed	0xAF	XOR
Zoom In	0xA0	Address	0x00	0x20	0x00	0x00	0xAF	XOR
Zoom Out	0xA0	Address	0x00	0x40	0x00	0x00	0xAF	XOR
Focus Far	0xA0	Address	0x00	0x80	0x00	0x00	0xAF	XOR
Focus Near	0xA0	Address	0x01	0x00	0x00	0x00	0xAF	XOR
Set Preset	0xA0	Address	0x00	0x03	0x00	Preset ID	0xAF	XOR
Clear Preset	0xA0	Address	0x00	0x05	0x00	Preset ID	0xAF	XOR
Call Preset	0xA0	Address	0x00	0x07	0x00	Preset ID	0xAF	XOR
Auto Focus	0xA0	Address	0x00	0x2B	0x0	0x01	0xAF	XOR
Manual Focus	0xA0	Address	0x00	0x2B	0x00	0x02	0xAF	XOR
Query Pan Position	0xA0	Address	0x00	0x51	0x00	0x00	0xAF	XOR
Query Pan Position Response	0xA0	Address	0x00	0x59	Value High Byte	Value Low Byte	0xAF	XOR
Query Tilt Position	0xA0	Address	0x00	0x53	0x00	0x00	0xAF	XOR
Query Tilt Position Response	0xA0	Address	0x00	0x5B	Value High Byte	Value Low Byte	0xAF	XOR
Query Zoom Position	0xA0	Address	0x00	0x55	0x00	0x00	0xAF	XOR
Query Zoom Position Response	0xA0	Address	0x00	0x5D	Value High Byte	Value Low Byte	0xAF	XOR

On Screen Display Menu

Main Menu

There are many ways to adjust the camera's On Screen Display (OSD) Menu. The following instructions will go over the OSD Menu while using the included IR remote.

Press the [MENU] button to display the OSD Menu. Use the arrow buttons to traverse the OSD menu, the [HOME] button to make selections, and the [RETURN] button to go back a sub menu.

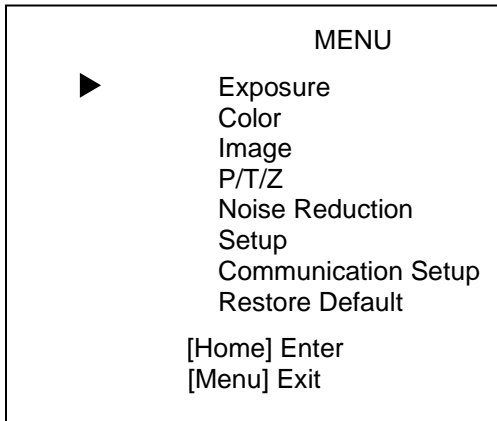

Exposure

Move the cursor to the "Exposure" option and press the [HOME] button to enter the Exposure page, as shown in the figure below.

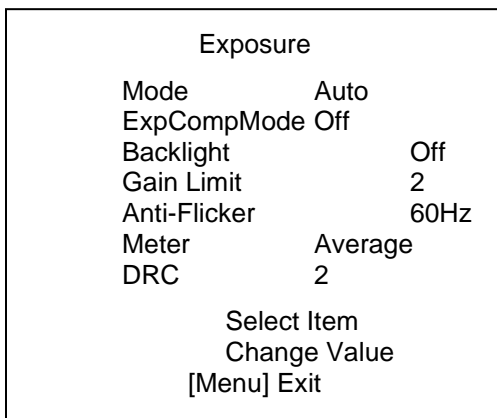

Exposure Mode: Modes include: Auto, Manual, SAE, AAE, Bright

ExpCompMode: Exposure Compensation mode
Options include: On, Off
(Only available in Auto mode)

ExpComp: Exposure Compensation value.
Options include: -7 ~ +7
(Only available once ExpCompMode is On)

Backlight: Backlight Compensation mode
Options include: On, Off
(Only available in Auto mode)

Bright: Brightness Intensity.
Options include: 0 ~ 17
(Only available in Bright mode)

Gain Limit: Maximum Gain Limit.
Options include: 0 ~ 15
(Only available in SAE, AAE, & Bright modes)

Anti-Flicker: Anti-Flicker (lighting)
Options include: Off, 50Hz, 60Hz
(Only available in Auto, AAE, & Bright modes)

Iris: Camera Iris value.
Options include: Close, F11.0, F9.6, F8.0, F6.8, F5.6, F4.8, F4.0, F3.4, F2.8, F2.4, F2.0, F1.8
(Only available in AAE & Manual modes)

Shutter: Camera Shutter value.
Options include: 1/30, 1/60, 1/90, 1/100, 1/125, 1/180, 1/250, 1/350, 1/500, 1/725, 1/1000, 1/1500, 1/2000, 1/3000, 1/4000, 1/6000, 1/10000
(Only available in SAE & Manual modes)

DRC: Dynamic Range Control strength.
Options include: 0 ~ 8

Color

Move the cursor to the "Color" option and press the [HOME] button to enter the Color page, as shown in the figure below.

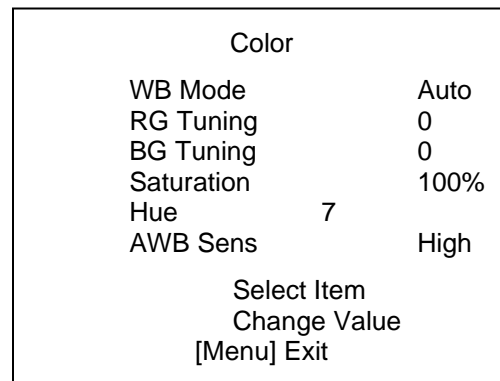

WB Mode: Modes include: Auto, Indoor, Outdoor, OnePush, Manual, VAR

RG: Red Gain value.
Options include: 0 ~ 255
(Only available in Manual mode)

BG: Blue Gain value.
Options include: 0 ~ 255
(Only available in Manual mode)

ColorTemp: Color Temperature (Kelvin)
Options include: 2500K ~ 8000K
(Only available in VAR mode)

RG Tuning: Red Gain Tuning.
Options include: -10 ~ +10
(Only available in Auto, OnePush, & VAR)

BG Tuning: Blue Gain Tuning.

Options include: -10 ~ +10
(Only available in Auto, OnePush, & VAR)

Saturation: Color Saturation value.

Options include: 60% ~ 200%

Hue: Color Hue value.

Options include: 0 ~ 14

AWB Sens: Auto White Balance Sensitivity.

Options include: Low, Medium, High
(Only available in Auto & OnePush modes)

Image

Move the cursor to the “Image” option and press the [HOME] button to enter the Image page, as shown in the figure below.

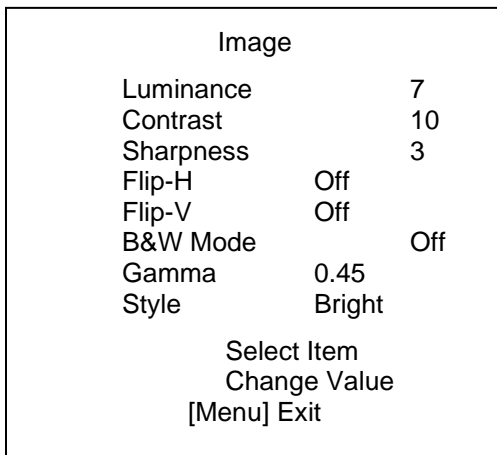

Luminance: Brightness value.

Options include: 0 ~ 14

Contrast: Contrast value.

Options include: 0 ~ 14

Sharpness: Sharpness value.

Options include: Auto, 0 ~ 15

Flip-H: Flip image horizontally.

Options include: On, Off

Flip-V: Flip image vertically.

Options include: On, Off

B&W Mode: Toggle Black & White mode.

Options include: On, Off

Gamma: Gamma value.

Options include: Default, 0.45, 0.5, 0.56, 0.63

Style: Camera image style.

Options include: Norm, Clarity (LED), Clarity, Bright, Soft, 5S

P/T/Z

Move the cursor to the “P/T/Z” option and press the [HOME] button to enter the P/T/Z page, as shown in the figure below.

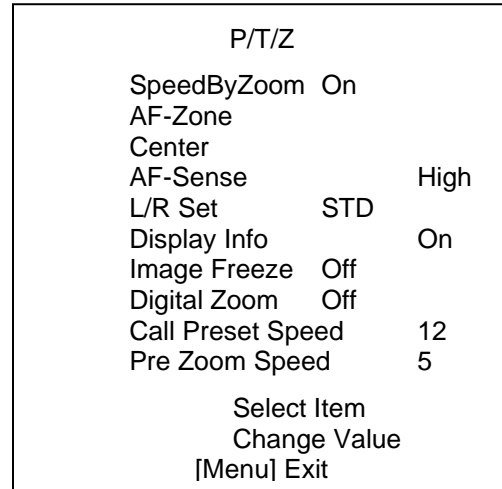

Noise Reduction

Move the cursor to the “Noise Reduction” option and press the [HOME] button to enter the Noise Reduction page, as shown in the figure below.

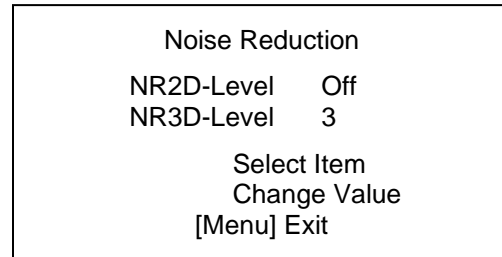

NR2D-Level: 2D noise reduction value.

Options include: Auto, Off, 1 ~ 5

NR3D-Level: 3D noise reduction value.

Off, 0 ~ 8

Setup

Move the cursor to the “Setup” option and press the [HOME] button to enter the Setup page, as shown in the figure below.

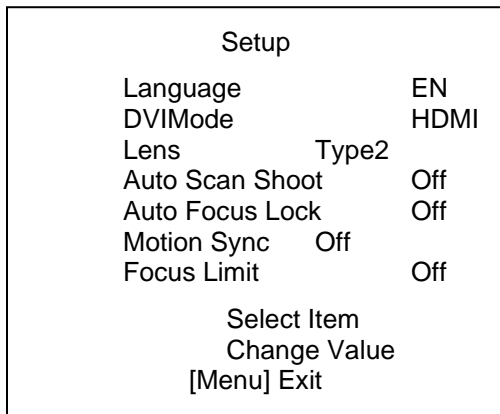

Language: OSD language.

Options include: English, Chinese, Russian, French, Spanish, Italian, German

DVIMode:

Options include: HDMI, DVI

Lens:

Options include: Type2, Type1

Auto Scan Shoot: Call presets 1 & 2 (alternating).

Options include: On, Off

Auto Focus Lock: Lock focus at current value.

Options include: On, Off

Motion Sync: P/T/Z synced presets.

Options include: On, Off

Max Speed: Max Motion Sync preset speed.

Options include: 185 ~ 230

(Only available when Motion Sync is On)

Focus Limit: Manually limit focus range.

Options include: On, Off

Furthest Pos: Furthest object in defined focal range.

Options include: INF, 1m ~ 20m

(Only available when Focus Limit is On)

Nearest Pos: Nearest object in defined focal range.

Options include: INF, 1m ~ 20m

(Only available when Focus Limit is On)

Communication Setup

Move the cursor to the “Communication Setup” option and press the [HOME] button to enter the Communication Setup page, as shown in the figure below.

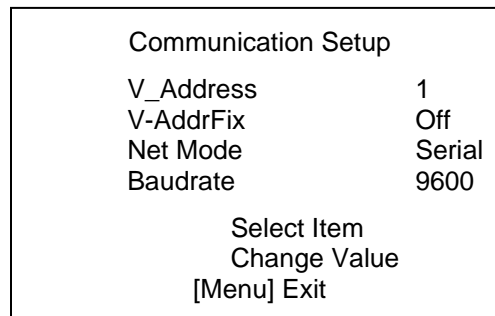

V_Address: VISCA control address.

Options include: 0 ~ 7

V-AddrFix: Prevent VISCA address from changing.

Options include: On, Off

Net Mode: Control type.

Options include: Paral, Serial

Baud Rate: Baud Rate speed.

Options include: 2400, 4800, 9600, 38400

P_D_Address: Pelco-D control address.

Options include: 0 ~ 254

P_P_Address: Pelco-P control address.

Options include: 0 ~ 31

Restore Default

Move the cursor to the “Restore Default” option and press the [HOME] button to enter the Restore Default page, as shown in the figure below.

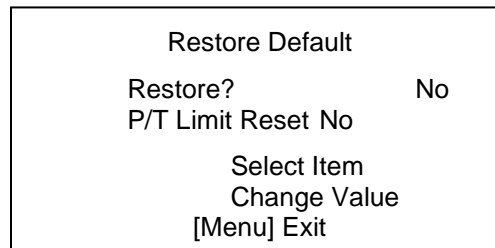

Restore?: Restore OSD settings to default value.

Options include: Yes, No

P/T Limit Reset: Reconfigure pan & tilt parameters.

Options include: Yes, No

Note: Press the [HOME] button to confirm. All camera parameters will return to default, including IR remote & VISCA addresses

Network Connection

1. Operating Environment

Operating System: Windows 2000 / 2003 / XP / Vista / 7 / 8.1 / 10, Mac Catalina and later

Network Protocol: TCP/IP

Client PC: P4 / 128M RAM / 40GHD / support for scaled graphics card, support for DirectX8.0 or more advanced version.

2. Equipment Installation

1. Connect the camera to your network via a CAT5 or CAT6 cable directly to your network switch.
2. Turn on the camera.
3. Once powered on, the orange network light will illuminate and the green light will start flashing.

3. Network Connection

Connect the camera & PC to the LAN as shown below.

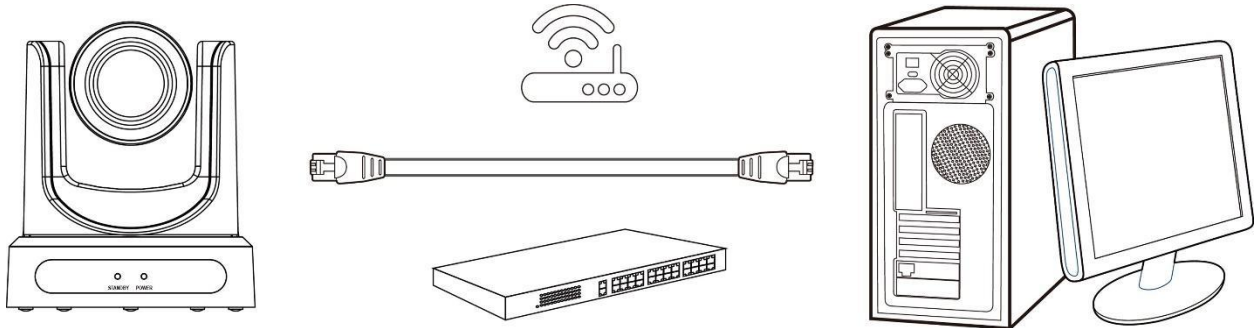

Connections to LAN via CAT5 or CAT6 cable

Assigning an IP Address

By default, the camera has the IP address “192.168.100.88”. You have several methods to change this IP address to match your network scheme. Please see the instructions below for your preferred setup.

DHCP

If your network supports DHCP, you can have it automatically assign an IP using one of the methods below.

- IR Remote – Press [*] > [#] > [4] to enable DHCP
- Upgrade Tool v2.7/v2.8 – Select DHCP from Config the tab

Static Address

If you want to give your camera a more permanent IP address, assign the camera a static IP address. You have two (2) options to assign this address.

1. Upgrade Tool v2.7/v2.8 – Assign a static IP address from the Config tab
2. IR Remote – Press [#] > [*] > [#] > [number 0~9] to set the camera’s IP address to 192.168.100.8(number 0~9)



For more information on using the Upgrade tool, please see Using the Upgrade Tool below.

Using the Upgrade Tool

You can use the Upgrade Tool to assign a dynamic IP address, static IP address, firmware upgrade the camera, backup core files, and lastly; restore core files. Please follow the instructions below for best use.

Search Tab

Use the Search Tab to find your camera on your network. The “Interface” drop down allows you to select which network to search. After selecting the proper network type, click the “Search” button to begin your search.

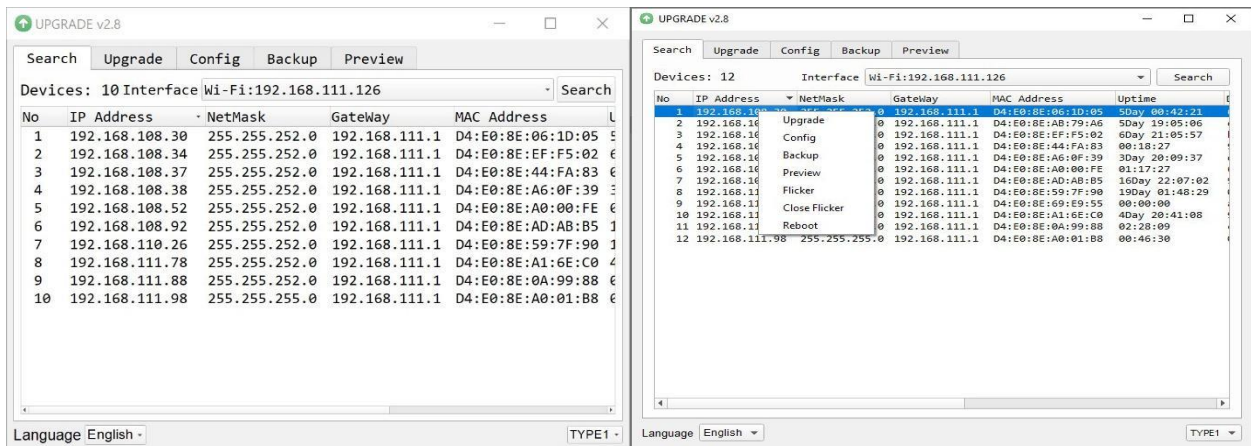

Once you find the camera you wish to adjust, right click the corresponding IP address to reveal the control menu. From here, select the corresponding tab for the way you want to adjust your camera.

Upgrade Tab

The Upgrade Tab allows you to firmware upgrade the camera. To acquire the latest firmware for your PTZOptics camera, for to <https://ptzoptics.com/firmware-finder>.

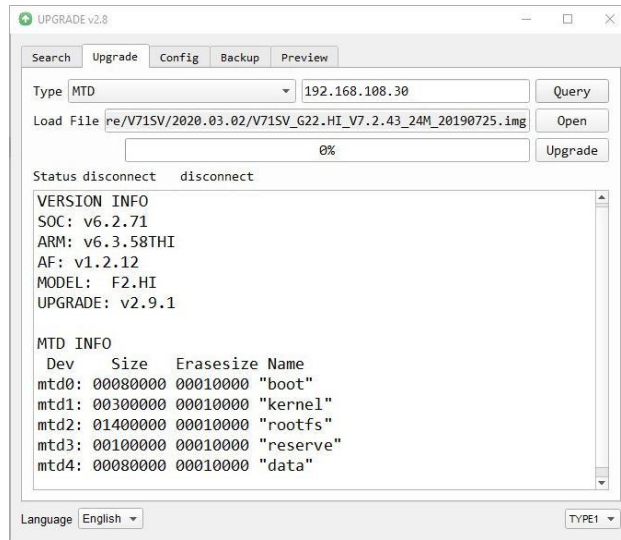

To ensure you follow the proper firmware upgrade method, follow the [PTZOptics SDI/NDI Firmware Upgrade Instructions](#).

Config Tab

The Config tab allows you to change the network parameters of a camera. To properly access this interface, right-click a camera from the Search tab, and select “Config” from the menu.

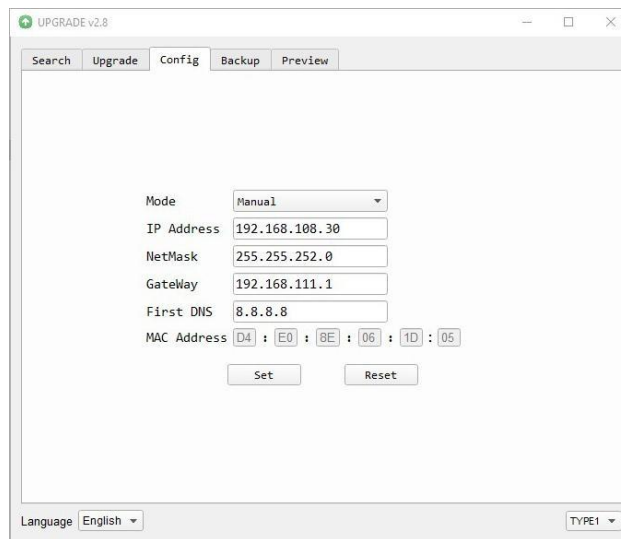

To assign a static IP address, you’ll need to know of a free IP address in your network range, your subnet mask, Gateway, & First DNS.



To find this information, check out the section [Discovering your Network Info](#) below.

Alternatively, you can click the “Mode” dropdown and select “DHCP” to have your network auto fill this information.

In either case, once the network information is filled, click the “Set” button to apply these parameters. The camera will restart with the new network settings.

Backup Tab

The Backup tab allows you to backup and restore files. For best results, name each backup file something specific to the camera (such as the serial number).

These files consist of:

- Serial Number
- MAC Address¹
- Presets²
- Other core camera files.

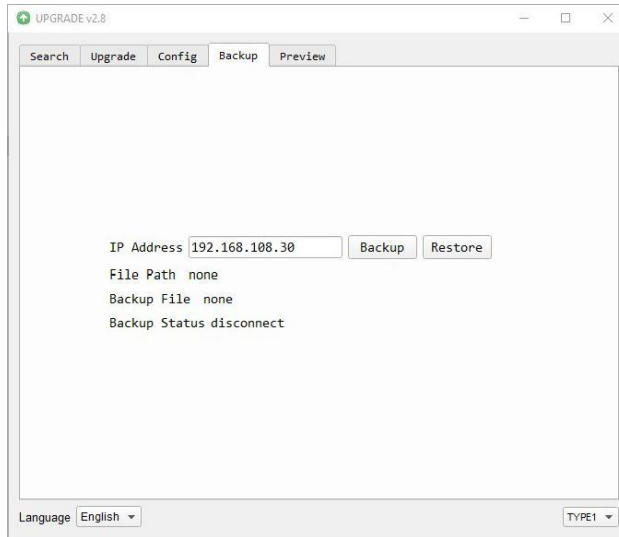

¹Because the MAC Address is stored in this backup file, ensure you do not apply/restore it to a different camera, as that will change the second camera's MAC address to the first camera's MAC address.

²Presets are not always saved properly and may need to be reset.

Preview Tab

The Preview tab allows you to view the RTSP feed of your camera. You can send the camera to the Preview tab from the Search tab, or simply type in the IP address into the field and click "Connect".

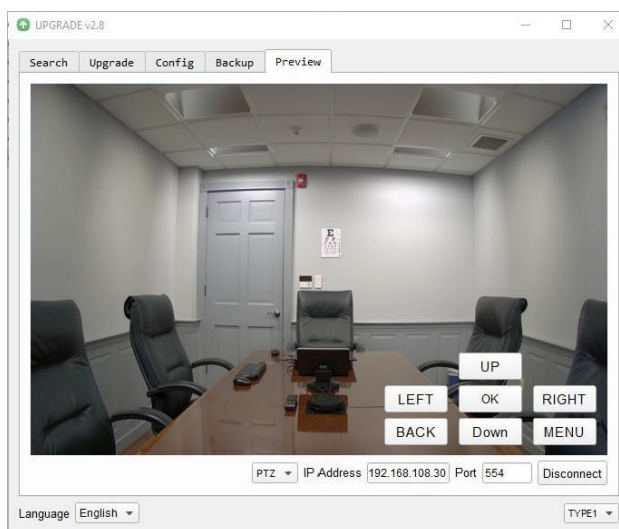

Discovering your Network Info

To discover your IP address range/scheme, Subnet Mask, Gateway, & First DNS, follow the instructions below for Windows or Mac OS. You may need to talk with your IT department to obtain this information.

Windows

1. Open the Start menu and type “CMD” into the search bar.
2. Once the Command Prompt is open, type in “ipconfig” and press the Enter key.
3. Scroll down to the section titled “Ethernet adapter Ethernet” or “Ethernet adapter Wireless Network Connection”.
4. Locate the “IPv4 Address” in that section. This is your computer’s local IP address.

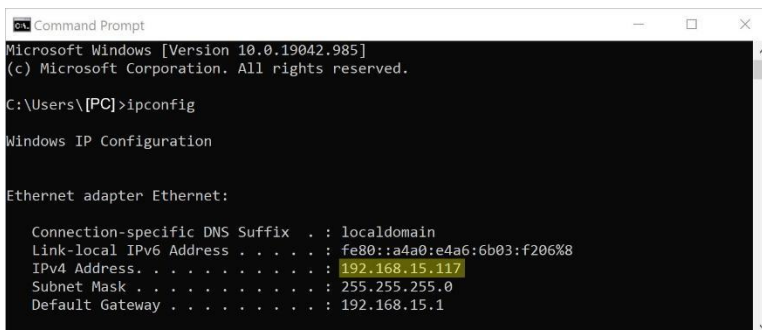

```
Command Prompt
Microsoft Windows [Version 10.0.19042.985]
(c) Microsoft Corporation. All rights reserved.

C:\Users\[PC]>ipconfig

Windows IP Configuration

Ethernet adapter Ethernet:

    Connection-specific DNS Suffix  . : localdomain
    Link-local IPv6 Address . . . . . : fe80::a4a0:e4a6:6b03:f206%8
    IPv4 Address. . . . . : 192.168.15.117
    Subnet Mask . . . . . : 255.255.255.0
    Default Gateway . . . . . : 192.168.15.1
```

5. In the example above, the PC’s local address is “192.168.15.117”, making the network range “192.168.15”.

Mac

1. Open a new Finder window and go to the Applications folder.
2. Open the Utilities folder and select the Terminal program.
3. Once the Terminal program is open, type in “ipconfig getifaddr en0” and press the Enter key.

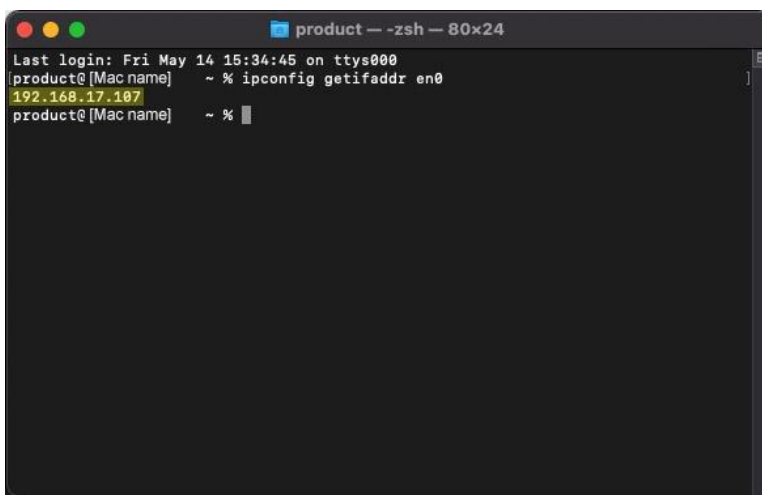

```
product --zsh-- 80x24
Last login: Fri May 14 15:34:45 on ttys000
product@[Mac name] ~ % ipconfig getifaddr en0
192.168.17.107
product@[Mac name] ~ %
```

4. In the example above, the Mac’s local address is 192.168.17.107”, making the network range “192.168.17”.

Camera Web Interface

The Web Interface allows you to control the camera, view the video feed, and adjust many of the camera's settings.

Menu

The Menu allows you to traverse the Web Interface. By default, the "Live" option is selected.

Live

This tab allows you to view the video feed of the camera.

The status bar below the video feed can be used to pause / play the video feed, adjust the audio level, and switch between full screen and windowed view.

The plugin dropdown allows you to select how you view the RTSP feed in the web interface. For best results, set the Second Stream to "MJPEG", and select the "JPEG" from the plugin dropdown.

The Preset Information button allows you to Set, Call, and Name presets 1 ~ 9.

Directional Arrows

Use the PTZ / OSD dropdown to select how the Directional Arrows behave. While "PTZ" is selected, you will have control over Pan, Tilt, and calling the Home position. When "OSD" is selected, the On Screen Display Menu will open, allowing you to use the Directional Arrows to traverse the OSD Menu.

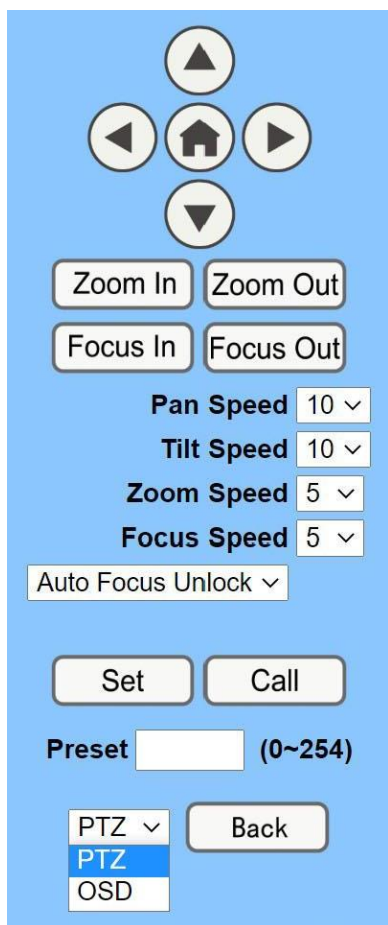

Directional Arrows: Use the Up / Down / Left / Right buttons to Pan / Tilt the camera or traverse the OSD Menu.

Home Button: Use the Home Button to send the camera to the Home position, or to make a selection within the OSD Menu.

Zoom In / Out: Use the Zoom In and Zoom Out buttons for narrow (tele) or wide views of the scene.

Focus In / Out: Use the Focus In and Focus Out buttons to make manual focus adjustments of the scene.

Speed Control: Use the Pan, Tilt, Zoom, and Focus Speed dropdowns to adjust the speed at which you control the camera.

Auto Focus Lock: Use the Auto Focus Unlock / Lock dropdown to manually lock the focus in the current position.

PTZ Presets: After manually positioning the camera in a position you wish to return to; you can save the position as a PTZ Preset. Type a number between 0 ~ 254 into the Preset box and press the "Set" button to save that position. Click the "Call" button to send the camera back to the PTZ Preset position.

PTZ / OSD Dropdown: Use the PTZ / OSD Dropdown to select Pan / Tilt / Zoom control, or On Screen Display Menu Control.

Video

Video Settings

720p120: On Off

Video Format: 60Hz ▾

Encode Level: highprofile ▾

NDI Preset: High ▾

First stream

Encode Protocol: H264 ▾

Resolution: 1920x1080 ▾

Bit Rate: 12288 (32~20480) kbps

Frame Rate: 60 ▾ fps

I Key Frame Interval: 120 (2~1200)

Bit Rate Control: CBR VBR

Fluctuate Level: 1 ▾

Slice Split Enable: On Off

Split Mode: Fixed blocks Fixed bytes

Slice Size: 68 blocks/bytes

Second stream

Encode Protocol: H264 ▾

Resolution: 640x360 ▾

Bit Rate: 2048 (32~6144) kbps

Frame Rate: 30 ▾ fps

I Key Frame Interval: 60 (2~1200)

Bit Rate Control: CBR VBR

Fluctuate Level: 1 ▾

Slice Split Enable: On Off

Split Mode: Fixed blocks Fixed bytes

Slice Size: 23 blocks/bytes

Video Format: Supports 50Hz (PAL), 60Hz (NTSC), & Dial Priority formats.

Encode Level: Supports baseline, mainprofile, highprofile, & SVC-T.

NDI Preset: Supports Off, Low, Medium, & High.

Encode Protocol: Supports H.264, H.265, & MJPEG

Resolution: The first stream supports 1920x1080, 1280x720, 1024x576, 960x540, 640x480, 640x360. The second stream supports 1280x720, 1024x576, 720x480, 720x408, 640x360, 480x270, 320x240, 320x180.

Bit Rate: Adjust the maximum bit rate of the network video. The higher the bit rate, the clearer the image will be. *Bit rates set too high can congest the network and cause the video to not transmit properly, causing the video to appear worse.*

Range: 32 ~ 20480 kbps.

Frame Rate: Adjust the frame rate of the network video. The higher the frame rate the smoother the video feed will appear.

I KeyFrame Interval: Adjust how frequently a keyframe is produced.

Bit Rate Control: Supports Constant bit rate (CBR) & Variable bit rate (VBR).

Fluctuate Level: Limit the fluctuation magnitude of variable rate. Supports 1 ~ 6.

Splice Split Enable: Enable / Disable splice split function.

Split Mode: Supports Fixed blocks and Fixed bytes.

Slice Size: Set the slice size.

Image

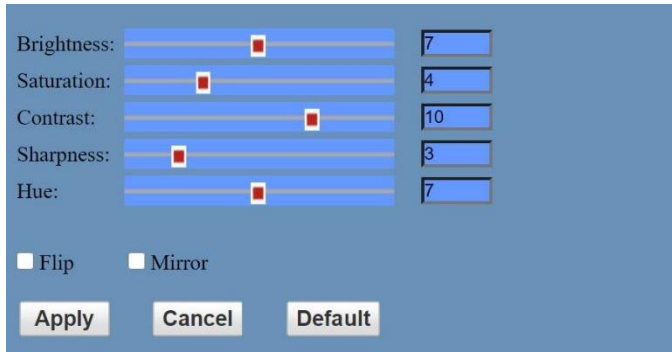

Brightness: Brightness slider. Default: 7

Saturation: Saturation slider. Default: 4

Contrast: Contrast slider. Default: 10

Sharpness: Sharpness slider. Default: 3

Hue: hue slider. Default: 7

Flip & Mirror: Check the Flip and/or Mirror button to rotate the image accordingly.

Audio

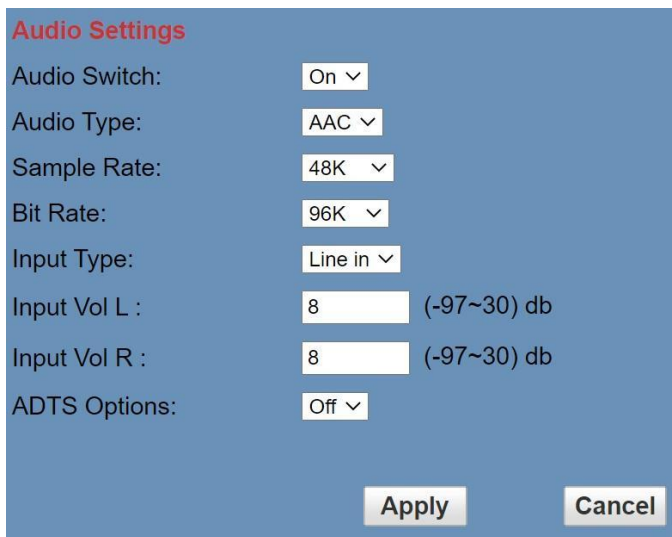

Audio Switch: Enable / Disable audio embedding.

Audio Type: AAC

Sample Rate: Options include: 44.1K & 48K

Bit Rate: Options include: 96K, 128K, & 256K.

Input Type: Line in.

Input Vol L: Volume of left channel. -91 ~ +30 dB

Input Vol R: Volume of right channel. -91 ~ +30 dB

ADTS Options: Enable / Disable Audio Data Transport Stream.

System

Work Mode: Options include: RTSP, SDK, & Multicast.

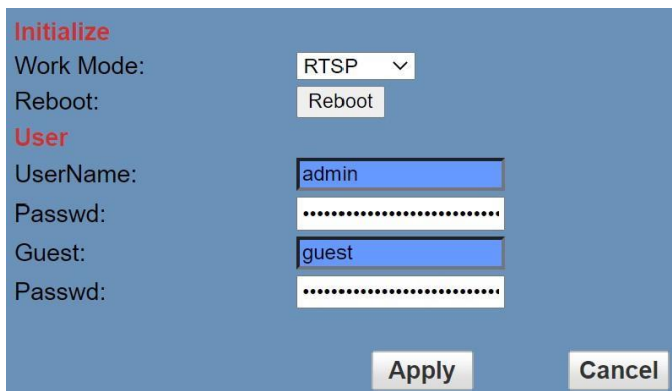

Reboot: Used to power cycle the camera.

Username: Username to log in to device.
Username: "admin"

Password: Password to log in to device.
Default password: "admin"

Guest (Username): Guest username to log in to device.
Username: "guest".

Guest (Password): Guest password to log in to device.
Default password: "guest".

Note: The custom password field is limited to 15 characters. Passwords longer than this will be forced to 15 characters.

Network

Lan Settings

IP Configuration Type: Fixed IP Address

IP Address: 192.168.108.44

Subnet Mask: 255.255.252.0

Gateway: 192.168.111.1

DNS Address: 192.168.111.1

MAC Address: D4 : E0 : 8E : 01 : A6 : 98

Apply Cancel

Port Settings

HTTP Port number: 80 (80)

RTSP Port: 554 (554)

PTZ Port: 5678 (5678)

UDP Port: 1259 (1259)

Sony Visca: 52381

SRT Settings

SRT: On Off

SRT Port: 4578

SRT Encry: Off

SRT Password: 1234567891 (SRT Password length greater than 9 bits)

Control Protocol Settings

Pelco-D Address: 0 (0-254)

Pelco-P Address: 0 (0-31)

RTMP(S) Settings

First stream: On Off Video Audio

MRL: rtmp://192.168.100.138/live/stream0

Second stream: On Off Video Audio

MRL: rtmp://192.168.100.138/live/stream1

RTSP Settings

RTSP Auth: On Off

ONVIFSettings

ONVIF: On Off

ONVIF Auth: On Off

Multicast Settings

Multicast: On Off

Address: 234.1.2.88

Port: 6688

SDK Settings

Active Connection: On Off

Address: 192.168.100.138

Port: 1234

NTP Settings

time zone: (GMT-05:00) Eastern Time (US & Canada)

NTP time sync: On Off

NTP Address: Windows NTP Mac NTP Custom NTP

Server address: time.apple.com

Time interval: 1440 minutes

Main time show: On Off

Position: X 0 Y 0 (0~100)

Sub time show: On Off

Position: X 0 Y 0 (0~100)

Apply Cancel

LAN Settings: The LAN Settings section allows you to adjust the IP parameters of the camera. The default IP address of the camera is 192.168.100.99. You cannot change the MAC address.

IP Configuration Type: Fixed IP Address (Static) & Dynamic IP Address (DHCP).

IP Address: Camera's IP address.

Subnet Mask: Network Subnet Mask.

Gateway: Network Gateway.

DNS Address: Network Domain Name Server address.

MAC Address: The camera's MAC address.

Apply & Cancel Buttons: Apply or cancel the changes made to the LAN Settings section.

Port Settings: The Port Settings section allows you to adjust the network ports of the camera.

HTTP Port: This port is used for HTTP-CGI control, and for the web application. Default: 80.

RTSP Port: This port is used for the RTSP streaming protocol. Default 554.

PTZ Port: This port is used for the TCP/IP control protocol. Default 5678.

UDP Port: This port is used for the UDP control protocol. Default: 1259.

Control Protocol Settings: The Control Protocol Settings section allows you to adjust the Pelco-D & Pelco-P control addresses.

Pelco-D Address: 0 ~ 254.

Pelco-P Address: 0 ~ 31.

RTMP(S) Settings: The RTMP(S) Settings section allows you to enable or disable the tw (2) RTMPS stream's video and audio sources.

First Stream: Enable / Disable Stream 1's Video & Audio.

(First Stream) MRL: Text field for RTMPS Stream 1's Media Resource Locator (MRL).

Second Stream: Enable / Disable Stream 2's Video & Audio.

(Second Stream) MRL: Text field for RTMPS Stream 2's Media Resource Locator (MRL).

RTSP Settings: The RTSP Settings section allows you to enable or disable RTSP Authorization.

RTSP Auth.: Enable / Disable RTSP authorization.

ONVIF Settings: The ONVIF Settings section allows you to adjust the ONVIF settings of the camera.

ONVIF: Enable / Disable the ONVIF protocol.

ONVIF Auth.: Enable / Disable ONVIF authorization

Multicast Settings: The Multicast Settings section allows you to adjust the Multicast settings of the camera.

Multicast: Enable / Disable the Multicast protocol.

Address: Adjust the Multicast address.

Port: This is the port used for the Multicast. Default: 6688.

SDK Settings: The SDK Settings section allows you to adjust the Software Development Kit settings of the camera.

Active Connection: Enable / Disable the SDK active connection.

Address: Adjust the Multicast address.

Port: This port is used for the SDK protocol. Default: 1234.

NTP Settings: The NTP Settings section allows you to enable / disable the Network Time Protocol of the camera.

Time Zone: Adjust the time zone you wish to use with NTP.

NTP Time Sync: Enable / Disable NTP Time Sync.

NTP Address: Enable Windows NTP, Mac NTP, or Custom NTP.

Server Address: Text field for Custom NTP server.

Time Interval: Adjust the Time Interval in minutes. Default: 1440

Main Time Show: Enable / Disable Main Time

Position: Main Time position

Sub Time Show: Enable / Disable Sub Time

Position: Sub Time position

NDI® Config

NDI® Config

NDI® Local Device Name: PTZOpticsCamera

NDI® Local Device Channel: Chan1

NDI® Receive Group: Public

Enable NDI® Discovery Server: On Off

NDI® Discovery Server: 192.168.1.2

Enable NDI® Multicast Server: On Off

NDI® Multicast Address: 239.255.0.10

NDI® Multicast Mask: 255.255.0.0

NDI® Multicast TTL: 1

NDI® Firmware Version: PT4.6.1

Apply Cancel

NDI® Local Device Name: The friendly name the camera will show up as within NDI® devices. For best results, give all ‘live’ cameras the same Local Device Name. e.g., ‘PTZ Cameras’ or “Box Cameras”.

NDI® Local Device Channel: The channel name the camera will utilize within NDI® devices. For best results, set a unique Local Device Channel for each camera. e.g., ‘Wide Shot’ or ‘Tight Shot’.

NDI® Receive Group: The NDI® Receive Group allows you to limit which users on your LAN can see the NDI® source. For best results, the Receive Group should remain “Public”. Once the Receive Group is changed, you will need to join the Receive Group through NDI® Access Manager.

Enable NDI® Discovery Server: Enable / Disable the NDI® Discovery server.

NDI® Discovery Server: Server address field when NDI® Discovery server is enabled.

Enable NDI® Multicast Server: Enable / Disable the NDI® Multicast Server.

NDI® Multicast Address: Multicast address field when NDI® Multicast server is enabled.

NDI® Multicast Mask: Used to adjust the NDI® Multicast Subnet Mask.

NDI® Multicast TTL: Used to adjust the Multicast Time-To-Live interval.

NDI® Firmware Version: Displays the current NDI® version on the camera.

For more information on how to utilize the NDI Discover server, check out <https://support.newtek.com/hc/en-us/articles/218109477-NDI-Discovery-and-Registration>.

NewTek®, NDI®, NDI® 4, & NDI®|HX are all registered trademarks by Vizrt Group®.

Information

The Information section displays the device information, firmware version, & device friendly name. You can adjust the device friendly name as needed to designate the camera.

Language

The Language selection dropdown allows you to change the language of the Web Interface. Select either “English”, “Chinese” (中文), or “Russian” (Русский).

PTZOptics HTTP-CGI Camera Control

HTTP-CGI – Control

Pan & Tilt

`http://[camera ip]/cgi-bin/ptzctrl.cgi?ptzcmd&[action]&[pan speed]&[tilt speed]`

[Action]: up, down, left, right, leftup, rightup, leftdown, rightdown, ptzstop

[Pan Speed]: 1 (Slowest) ~ 24 (Fastest)

[Tilt Speed]: 1 (Slowest) ~ 20 (Fastest)

Zoom

`http://[camera ip]/cgi-bin/ptzctrl.cgi?ptzcmd&[action]&[zoom speed]`

[Action]: zoomin, zoomout, zoomstop

[Zoom Speed]: 1 (Slowest) ~ 7 (Fastest)

Focus

`http://[camera ip]/cgi-bin/ptzctrl.cgi?ptzcmd&[action]&[focus speed]`

[Action]: focusin, focusout, focusstop

[Focus Speed]: 1 (Slowest) ~ 7 (Fastest)

Focus Lock

`http://[camera ip]/cgi-bin/param.cgi?ptzcmd&[action]_mfocus`

[Action]: lock, unlock

Home Position

`http://[camera ip]/cgi-bin/ptzctrl.cgi?ptzcmd&home`

PT Reset

`http://[camera ip]/cgi-bin/param.cgi?pan_tiltdrive_reset`

Preset

`http://[camera ip]/cgi-bin/ptzctrl.cgi?ptzcmd&[action]&[position number]`

[Action]: posset, poscall

[Position Number]: 0 ~ 89, 100 ~ 254

Direct Position Recall

`http://[camera ip]/cgi-bin/ptzctrl.cgi?ptzcmd&[mode]&[pan speed]&[tilt speed]&[pan position]&[tilt position]`

[Mode]: abs (Absolute position), rel (Relative position)

[Pan Speed]: 1 (Slowest) ~ 24 (Fastest)

[Tilt Speed]: 1 (Slowest) ~ 20 (Fastest)

[Pan Position]: 0001 ~ 0990 (pan right), FFFE ~ F670 (pan left), 0000 / FFFF (home position)

[Tilt Position]: 0001 ~ 0510 (tilt up), FFFE ~ FE51 (tilt down), 0000 / FFFF (home position)

Direct Zoom Recall

`http://[camera ip]/cgi-bin/ptzctrl.cgi?ptzcmd&zoomto&[zoom speed]&[zoom position]`

[Zoom Speed]: 0 (Slowest) ~ 7 (Fastest)

[Zoom Position]: 0000 (Full wide) ~ 4000 (Full tele)

HTTP-CGI – Navigation

OSD Access

http://[camera ip]/cgi-bin/param.cgi?navigate_mode&[mode]

[Mode]: OSD, PTZ

OSD Menu Navigation

http://[camera ip]/cgi-bin/ptzctrl.cgi?ptzcmd&[action]

[Action]: up, down, left, right

OSD Menu Selection

http://[camera ip]/cgi-bin/param.cgi?navigate_mode&[mode]

[Mode]: CONFIRM, OSD_BACK

HTTP-CGI – Image Adjustment

Image Settings

http://[camera ip]/cgi-bin/param.cgi?post_image_value&[mode]&[level]

[Mode]: bright, saturation, contrast, sharpness, hue

[Level]: 0 ~ 14

Image Orientation

http://[camera ip]/cgi-bin/param.cgi?post_image_value&[mode]&[state]

[Mode]: flip, mirror

[State]: 1 (flip / mirror), 0 (default)

Default Image Settings

http://[camera ip]/cgi-bin/param.cgi?get_image_default_conf

HTTP-CGI – Inquiries

Video

http://[camera ip]/cgi-bin/param.cgi?get_media_video

Network Video Configuration

Audio

http://[camera ip]/cgi-bin/param.cgi?get_media_audio

Network Audio Configuration

Network

http://[camera ip]/cgi-bin/param.cgi?get_network_conf

Network Configuration

Information

http://[camera ip]/cgi-bin/param.cgi?get_device_conf

Camera Information

Serial Number

http://[camera ip]/cgi-bin/param.cgi?get_serial_number

Serial Number **Not always accurate*

Photobooth Functionality

Your PTZOptics camera can quickly and easily take a series of four (4) still image or video files that are stored on the camera and made accessible with a standard web browser on the same network.

Photos

You have two (2) options to initiate a series of four (4) still images to be captured...

You can enter the following HTTP string into any web browser on the same network as the camera to initiate a series of four (4) still images.

```
http://[camera ip]/cgi-bin/booth.cgi?0&4&[delay]&photo&0
```

In this example, **[Delay]** is utilized to add additional delay, in seconds, between still images being taken. **[Delay]** can have any value from 1 ~ 9 seconds.

You can also press the “[F1]” button on your IR remote to initiate a “quick capture” that has, approximately, a four (4) second delay between four (4) still images being captured.

To retrieve your series of four (4) still images, you will need to open a standard web browser with network access to the camera and use the following HTTP strings to retrieve the still image files as desired.

Image 1: http://[camera ip]/photo1.jpg
Image 2: http://[camera ip]/photo2.jpg
Image 3: http://[camera ip]/photo3.jpg
Image 4: http://[camera ip]/photo4.jpg

Videos

You have two (2) options to initiate a series of four (4) videos being captured...

You can enter the following HTTP string into any web browser on the same network as the camera to initiate a series of four (4) video recordings.

```
http://[camera ip]/cgi-bin/booth.cgi?0&4&[delay]&video&[length]
```

In this example, **[Delay]** is utilized to add additional delay, in seconds, between videos being taken. **[Delay]** can have any value from 1 ~ 9 seconds.

In this example, **[Length]** is utilized to adjust the overall length, in seconds, of each video file. **[Length]** can have any value from 1 ~ 10 seconds.

You can also press the “[F2]” button on your IR remote to initiate a “quick capture” that has, approximately, a four (4) second delay between the four (4) ten (10) second videos being captured.

To retrieve your series of four (4) video files, you will need to open a standard web browser with network access to the camera and use the following HTTP strings to retrieve the still image files as desired.

Video 1: http://[camera ip]/video1.mp4
Video 2: http://[camera ip]/video1.mp4
Video 3: http://[camera ip]/video1.mp4
Video 4: http://[camera ip]/video1.mp4

Note: It can take the camera time for the video files to be fully captured and processed. If they are not retrievable, please wait an additional 30 ~ 60 seconds for the process to complete.

Maintenance and Troubleshooting

Unqualified Applications

- Do not shoot extremely bright objects for a long period of time, such as sunlight, ultra-bright light sources, etc.
- Do not operate close to powerful electromagnetic radiation, such as TV or radio transmitters, etc.

Troubleshooting

- No image
 - Check whether the power cord is connected, voltage is OK, & Power LED is illuminated.
 - Check whether the camera can “self-test” after startup (camera will do a brief pan/tilt tour and return to the home position, or preset 0, if that preset is set).
 - Check that the video cable is connected correctly.
 - If SDI, make sure that the destination device is accessing the SDI port that you plugged into.
 - If HDMI, make sure that the destination device is accessing the HDMI port that you plugged into.
 - Check that the lens cap is not installed onto the camera lens.
 - Check that the iris is not closed.
- Abnormal display of image
 - Check the rotary dial on the back of the camera. Be sure to use a resolution and frame rate that is supported by your software / hardware.
- Image is shaky or vibrating
 - Check whether the camera is mounted solidly or sitting on a steady horizontal and level surface.
 - Check the building and any supporting furniture for vibration. Ceiling mounts are often affected by building vibration more than wall mounts.
 - Any external vibration that is affecting the camera will be more apparent when in tele zoom (zoomed in) settings.

Control

- IR Remote controller does not control the camera
 - Does one of the four (4) “Camera Select” buttons (top row of remote) light up when you press any of the buttons on the remote?
 - If not, change the batteries in the remote
 - Are the camera and remote set to the same IR address? When “Display Info” is enabled (within P/T/Z) in the OSD, the camera will display it’s IR address upon start up. Set the IR remote to the same IR address to control the camera.
 - Try removing other sources of IR interference (e.g. sunlight, fluorescent lighting, etc.)
- Serial communication does not control the camera
 - Make sure the camera is on and functioning with the IR remote controller.
 - Verify that the RS-232/RS-485 cable is connected correctly and using the proper pinout.
 - Verify the communication settings of the control software or device (e.g. joystick).
 - Verify that the communication port on the controlling device is activated (e.g. Com port on PC).
 - Verify that all communication settings in the OSD Setup Menu correlate to the commands being used (e.g. VISCA address).

Certifications

- FCC – Tested under FCC 47 CFR Part 15, Subpart B, Class A:2011, ANSI C63.4 – 2014
- CE – Tested under EMC 2014/30/EU
 - EN 55032:2015
 - EN 61000-3-2:2014
 - EN 61000-3-3:2013
 - EN 55035:2017
- RoHS – Tested under RoHS Directive 2011/65/EU & 2015/863
 - IEC 62321-3-1:2013
 - IEC 62321-5:2013
 - IEC62321-4:2013+AMD1:2017
 - IEC 62321-7-1:2015
 - IEC 62321-7-2:2017
 - IEC 62321-6:2015
 - IEC 62321-8:2017

Changelog

June/2021 – Rev 2.0	Release of User Manual “2.0” NDI®HX update to NDI® 4 on cameras
August/2020 – Rev 1.6	Updated warranty information